

Connected Smart

e-CATALOG
2026_1.0

E N G L I S H

ISEO[®]
ULTIMATE ACCESS TECHNOLOGIES



Connected Smart

New

Libra X Smart

The evolution of the ISEO electronic cylinder

Libra X features a renewed, modern, and essential design, while its native modularity ensures maximum installation flexibility and rapid intervention, allowing it to integrate seamlessly into any architectural context.



Door Controller Smart

To protect your access points

Door Controller Smart is ISEO's electronic control unit designed to manage access to any electrical device operated via relay, ensuring the highest level of security.





ARGO App



ARGO by ISEO

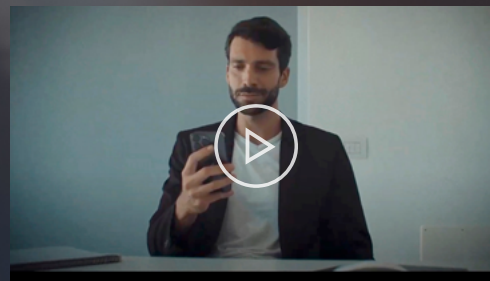

Open as you like. Even from remote.

Control smart devices of ISEO with the ARGO App.

Manage access to your spaces intuitively and securely, monitor activities in real time, and simplify permission management. With ARGO, you have total control by your side, wherever you are. Download it now and discover the future of security.

 [ARGO User Manual](#)

 [ARGO System Brochure](#)



download



download



Cybersecurity



ARGO is a reliable solution for access system security.

Cybersecurity in residential access control is crucial to ensure the safety of modern homes. For ISEO, security is very important. ISEO implements proven techniques based on industry best practices and derived from existing encryption and network security technologies. Thanks to direct connectivity to the locks and end-to-end encryption, without an intermediate server (the Cloud is only used as a bridge), ARGO ensures both local and remote connections with the same level of security. Locally, the app connects to the opening device directly via Bluetooth® Low Energy 5.1, ensuring maximum security with encryption techniques based on:

- Crypto AES 128
- Session keys generated with ECDH (Elliptic-curve Diffie-Hellman)
- Random Number Generator according to NIST (National Institute of Standards and Technology) specifications



Sustainability



In ISEO's ARGO access control sustainability is a priority.

By implementing efficient energy solutions and recyclable materials, ARGO reduces its environmental impact. In addition, wireless installation and keyless operation ensure less use of materials that are not easily recyclable, such as metal keys and cables. ARGO represents a sustainable option for access security without compromising the environment.



Libra X Smart electronic modular cylinder with RFID/Bluetooth reader and Standard mechanical knob.



ARGO system architecture

ISEO's cloud-connected wireless access control system is an advanced and versatile solution for managing doors and other types of access points, all facilitated by the absence of cabling thanks to the devices' on-board batteries and low energy technology. Thanks to cloud integration, the system offers secure and reliable connectivity, allowing real-time access to data and configurations. The system's scalability allows it to adapt to evolving needs, efficiently managing both small environments and larger buildings.

Up to 300 users per device

Unlimited number of devices and gateways per system

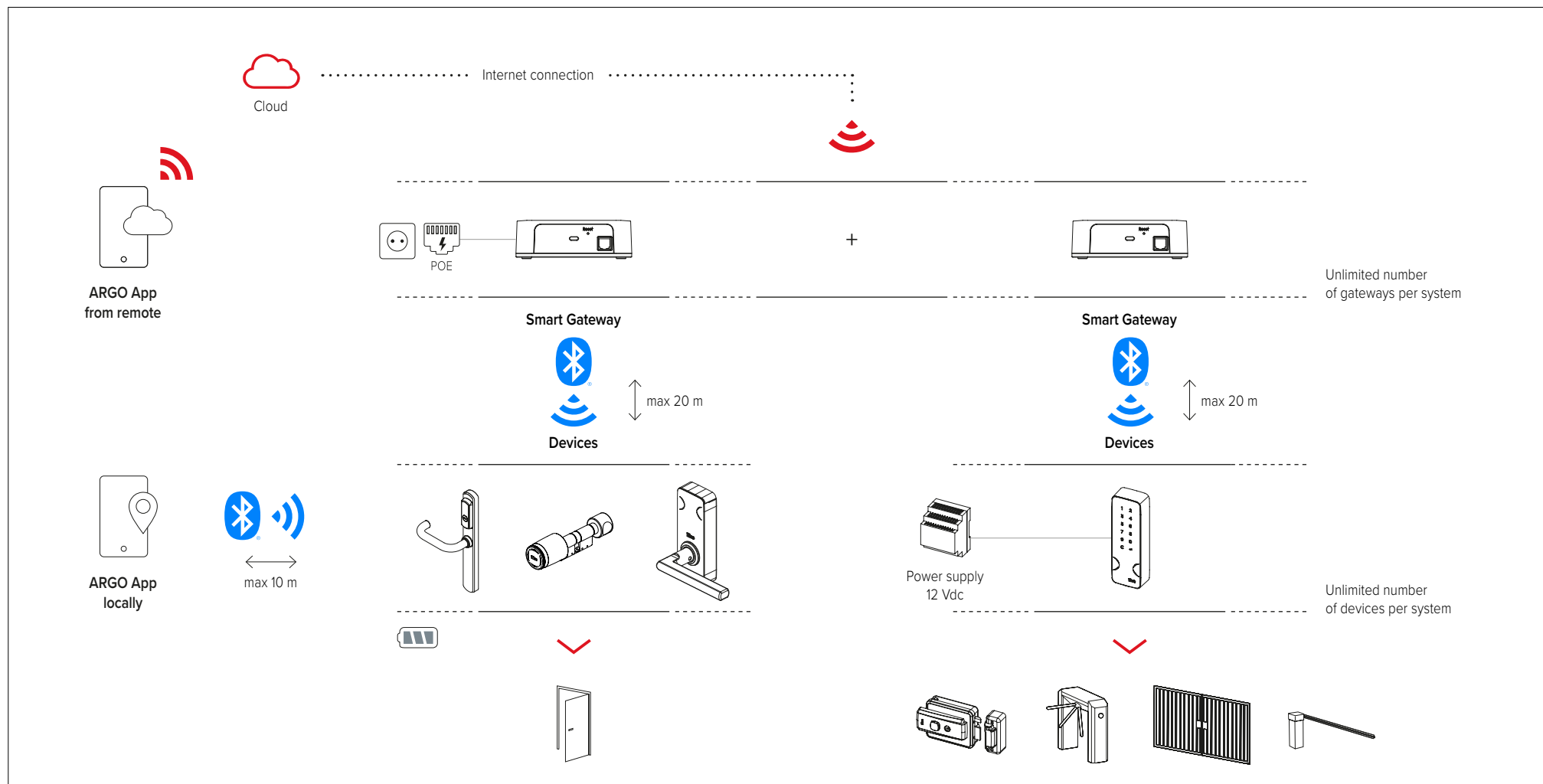

Success Stories

LAKE VILLA

Edificio residenziale, Henan, Cina

Residents of Lake Villa flats can open the doors of their homes in various ways: with their smartphone, a physical key or other credentials.

[Read more](#)



HOUSE AT BUKIT DAMANSARA

Villa Kuala Lumpur, Malesia

The private villa in Kuala Lumpur combines architectural elegance with advanced technological solutions.

[Read more](#)



Reading Guide

Home Button and Previous View

Device name

Device type

Device code

If there is the

 Code configurator

click to create the code using the configurator of the specific device

Quick navigation to devices' main pages

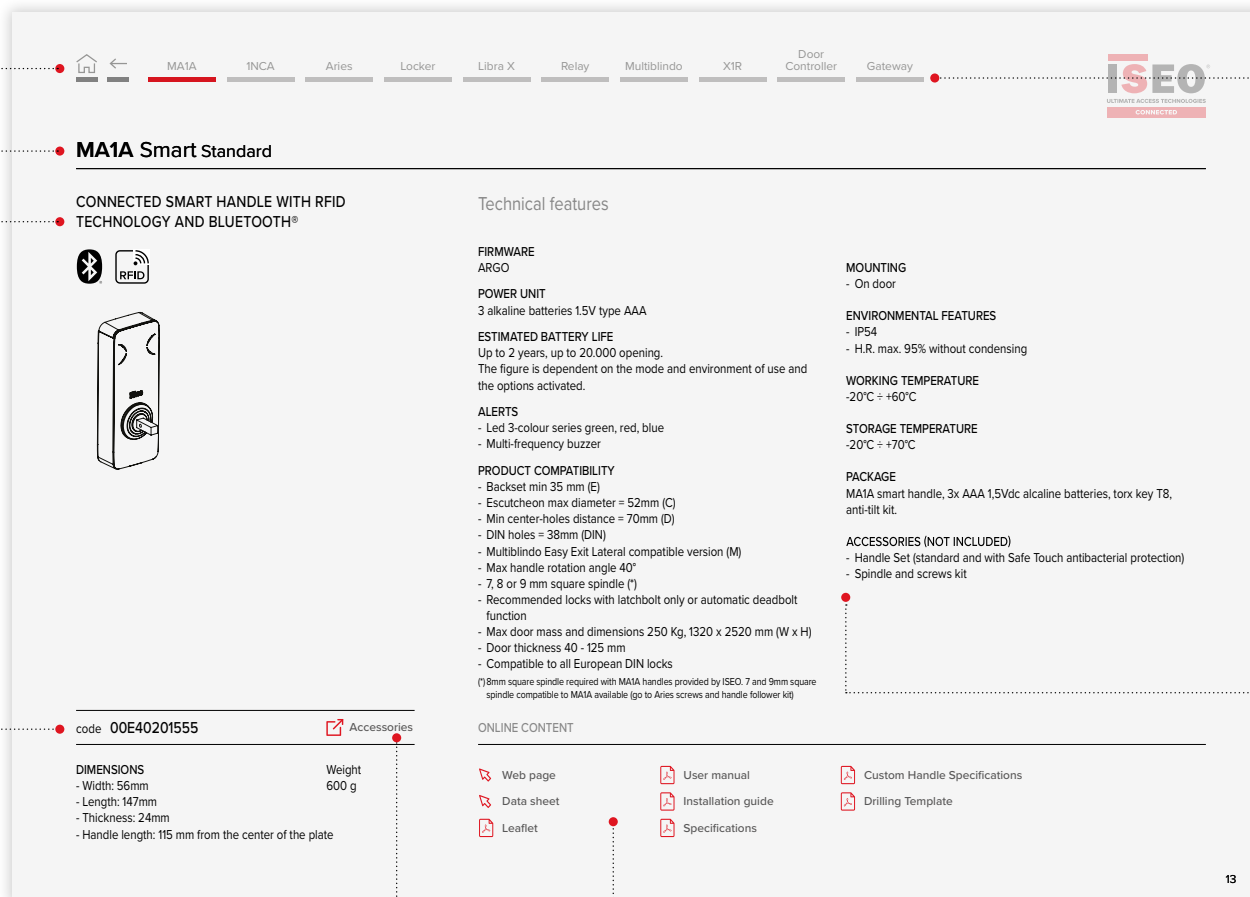

The screenshot shows the product page for the MA1A Smart Standard. At the top, there is a navigation bar with a home icon, a back arrow, and a list of product categories: MA1A, INCA, Aries, Locker, Libra X, Relay, Multiblindo, XIR, Door Controller, and Gateway. The ISEO logo is in the top right corner.

The main content area is divided into several sections:

- Device name:** MA1A Smart Standard
- Device type:** CONNECTED SMART HANDLE WITH RFID TECHNOLOGY AND BLUETOOTH®. Below this is an image of the device and icons for Bluetooth and RFID.
- Technical features:**
 - FIRMWARE:** ARGO
 - POWER UNIT:** 3 alkaline batteries 1.5V type AAA
 - ESTIMATED BATTERY LIFE:** Up to 2 years, up to 20,000 opening. The figure is dependent on the mode and environment of use and the options activated.
 - ALERTS:**
 - Led 3-colour series green, red, blue
 - Multi-frequency buzzer
 - PRODUCT COMPATIBILITY:**
 - Backset min 35 mm (E)
 - Escutcheon max diameter = 52mm (C)
 - Min center-holes distance = 70mm (D)
 - DIN holes = 38mm (DIN)
 - Multiblindo Easy Exit Lateral compatible version (M)
 - Max handle rotation angle 40°
 - 7, 8 or 9 mm square spindle (*)
 - Recommended locks with latchbolt only or automatic deadbolt function
 - Max door mass and dimensions 250 Kg, 1320 x 2520 mm (W x H)
 - Door thickness 40 - 125 mm
 - Compatible to all European DIN locks
 - MOUNTING:** - On door
 - ENVIRONMENTAL FEATURES:**
 - IP54
 - H.R. max. 95% without condensing
 - WORKING TEMPERATURE:** -20°C + +60°C
 - STORAGE TEMPERATURE:** -20°C + +70°C
 - PACKAGE:** MA1A smart handle, 3x AAA 1.5Vdc alkaline batteries, torx key T8, anti-tilt kit.
 - ACCESSORIES (NOT INCLUDED):**
 - Handle Set (standard and with Safe Touch antibacterial protection)
 - Spindle and screws kit
- Device code:** code 00E40201555. There is a link to accessories.
- DIMENSIONS:**
 - Width: 56mm
 - Length: 147mm
 - Thickness: 24mm
 - Handle length: 115 mm from the center of the plate
- Weight:** 600 g
- ONLINE CONTENT:**
 - Web page
 - Data sheet
 - Leaflet
 - User manual
 - Installation guide
 - Specifications
 - Custom Handle Specifications
 - Drilling Template

The page number 13 is visible in the bottom right corner.

Links to accessories pages

Links to online materials on iseo.com

Technical Data of the device

Search by device

MA1A Smart

Go to page



The smart handle for many applications

MA1A Smart is the new electronic lock of the ISEO Connected products range which allows to manage the access with simplicity in residential, "light commercial" environments, B&B. MA1A with its compact and stylish design is an excellence of Made in Italy and represents the perfect retrofit solution for internal doors.

Make your doors connected

MA1A Smart can be opened through ARGO the smartphone app conceived for iOS and Android device, with which the user can manage, monitor and open all the doors upon which MA1A has been installed - RFID cards, tags, key fob. The installation of the smart handle is quickly and effortlessly, is easy to use and it is compatible with all DIN mechanical locks.

Product's functions

- Memorize up to 300 users credentials
- Records the last 1000 events
- Battery-operated device with charge status detection
- Wake up by RFID card detection or phone Bluetooth® (patented)
- Low energy consumption device
- Real Time Clock/Calendar
- Light and acoustic signals
- Permanently open mode (office mode) without no extra battery consumption
- Block the Standard Users allowing access only to VIP users
- Programming and software updates by ARGO App on iOS and Android devices

FINISH

 Technopolymer

COLOR

 Glossy black

ENVIRONMENTAL CHARACTERISTICS

- IP54
- Max. 95% without condensing

CREDENTIALS

- Badge
- Keyfob
- Bracelet
- Smartphone
- Apple Watch

COMMUNICATION INTERFACE

- RFID ISO14443B/MIFARE ISO14443A
- Bluetooth® Low Energy 5.1

CERTIFICATIONS

- CE (Conformitee Europeenne)
- UKCA (UK Conformity Assessed)
- EN 16867:2020 with classification I3I7I0IBI14IB/D*0I0I
- EN 1634-1 fire resistance EI90

* B with MIFARE Classic cards,
D with MIFARE DESFire cards

MODELS

→ Standard

p. 13

MA1A Smart

Selection guide

The MA1A electronic handle is available with different handle sets.

The items required to adapt the different door types and to ensure correct installation are various and must be chosen from the options available according to the characteristics and the dimensions of the door and the specific usage requirements.

To ensure the correctness and completeness of the order below is a guide for the selection of the various articles that make up the set for each door.

ORDER THE PRODUCT IN A FEW STEPS

1

Check the type of door on which the MA1A Connected Smart Handle will be mounted.

3

Compose the necessary spindle and screws kit.

2

Choose the handle set you prefer.

4

Optional.
Choose **lock to match**.

Go to page

Go to page

Go to page

Go to page

● **SELECTION GUIDE**

MODELS

→ Standard

p. 13

MA1A Smart Standard

CONNECTED SMART HANDLE WITH RFID TECHNOLOGY AND BLUETOOTH®

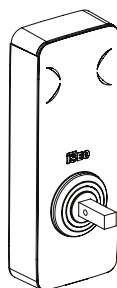

Technical features

FIRMWARE

ARGO

POWER UNIT

3 alkaline batteries 1.5V type AAA

ESTIMATED BATTERY LIFE

Up to 2 years, up to 20.000 opening.

The figure is dependent on the mode and environment of use and the options activated.

ALERTS

- Led 3-colour series green, red, blue
- Multi-frequency buzzer

PRODUCT COMPATIBILITY

- Backset min 35 mm (E)
- Escutcheon max diameter = 52 mm (C)
- Min center-holes distance = 70 mm (D)
- DIN holes = 38 mm (DIN)
- Multiblindo Easy Exit Lateral compatible version (M)
- Max handle rotation angle 40°
- 7, 8 or 9 mm square spindle (*)
- Recommended locks with latchbolt only or automatic deadbolt function
- Max door mass and dimensions 250 Kg, 1320 x 2520 mm (W x H)
- Door thickness 40 - 125 mm
- Compatible to all European DIN locks

(*) 8 mm square spindle required with MA1A handles provided by ISEO. 7 and 9 mm square spindle compatible to MA1A available (go to Aries screws and handle follower kit)

MOUNTING

- On door

ENVIRONMENTAL FEATURES

- IP54
- H.R. max. 95% without condensing

WORKING TEMPERATURE

-20°C ÷ +60°C

STORAGE TEMPERATURE

-20°C ÷ +70°C

PACKAGE

MA1A Smart handle, 3x AAA 1,5Vdc alkaline batteries, torx key T8, anti-tilt kit.

ACCESSORIES (NOT INCLUDED)

- Handle Set (standard and with Safe Touch antibacterial protection)
- Spindle and screws kit

code 00E40201555



DIMENSIONS

- Width: 56 mm
- Length: 147 mm
- Thickness: 24 mm
- Handle length: 115 mm from the center of the plate

Weight
600 g

ONLINE CONTENT

 Web page

 Data sheet

 Leaflet

 User manual

 Installation guide

 Specifications

 Custom Handle Specifications

 Drilling Template

MA1A Smart

Accessories

HANDLE SET

YUMA

MA1A Handle Set

Package: 1 MA1A external handle, 1 Internal handle, 1 Internal handle fixing plate with reinforcing spring and cover, 2 Internal and external cylinder escutcheons with covers.

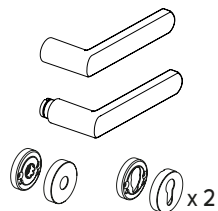

Zamak Alloy – Matte Black RAL 9005

1 00.329.005

WITH SAFE TOUCH ANTIBACTERIAL PROTECTION

Safe Touch treatment applied to external and internal handle.

1 00.329.005A



Zamak Alloy – Satin Chrome

1 00.329.00Y

WITH SAFE TOUCH ANTIBACTERIAL PROTECTION

Safe Touch treatment applied to external and internal handles.

1 00.329.00YA



URACAN

MA1A Handle Set

Package: 1 MA1A external handle, 1 Internal handle, 1 Internal handle fixing plate with reinforcing spring and cover, 2 Internal and external cylinder escutcheons with covers.

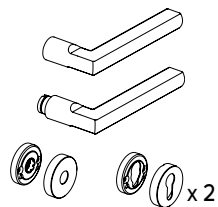

Stainless steel – Matte Black RAL 9005

1 00.431.005

WITH SAFE TOUCH ANTIBACTERIAL PROTECTION

Safe Touch treatment applied to external and internal handles.

1 00.431.005A

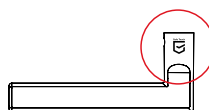

Satin Stainless steel

1 00.431.002

WITH SAFE TOUCH ANTIBACTERIAL PROTECTION

Safe Touch treatment applied to external and internal handles.

1 00.431.002A

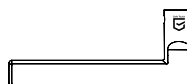

MA1A Smart

Accessories

SPINDLE AND SCREWS KIT

Spindle and screws length related to door thickness (A)
 Package includes: 1 square spindle, 2 M5 fixing screws with thread-locking.
 NOTE: select the right kit depending on door thickness.

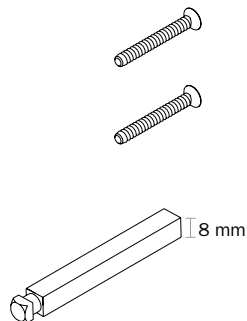

8 mm square spindle and 2xM5 screws kit

Door thickness from 40 to 50 mm	1	201E004050A
Door thickness from 50 to 60 mm	1	201E005060A
Door thickness from 60 to 70 mm	1	201E006070A
Door thickness from 70 to 80 mm	1	201E007080A
Door thickness from 80 to max 125 mm (to be cut)	1	201E008010A

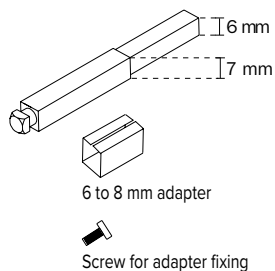

7 mm square spindle and 2xM5 screw kit

Door thickness from 40 to 50 mm	1	0000A00278
Door thickness from 50 to 60 mm	1	0000A00279
Door thickness from 60 to 70 mm	1	0000A00280
Door thickness from 70 to 80 mm	1	0000A00281

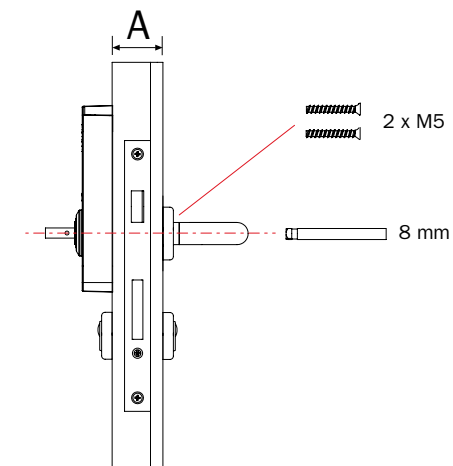

MA1A Smart

Accessories

LOCK CAN BE COMBINED

PANIC FIRE-RATED SELF-LOCKING LOCK

Panic self-locking lock for fire-resistant doors.

When the leaf is approached, the deadbolt of the lock is automatically engaged.

Internal operation:

The key operates the external handle (function B) and retracts the latch and deadbolt (only with function E).

The panic bar and/or emergency handle always retract the latch and deadbolt.

External operation:

The key enables/disables the handle that recalls the latch and deadbolt (function B).

72 mm center distance. 9 mm sintered steel handle follower set with 30° rotation.

Self-locking 20 mm deadbolt.

Zinc plated front plate (stainless steel option) with round edges (square edges option) 24x3 mm (20x3 mm option). NK sintered steel latch.

Compatible with Euro profile cylinder, with DIN cam to be ordered separately.

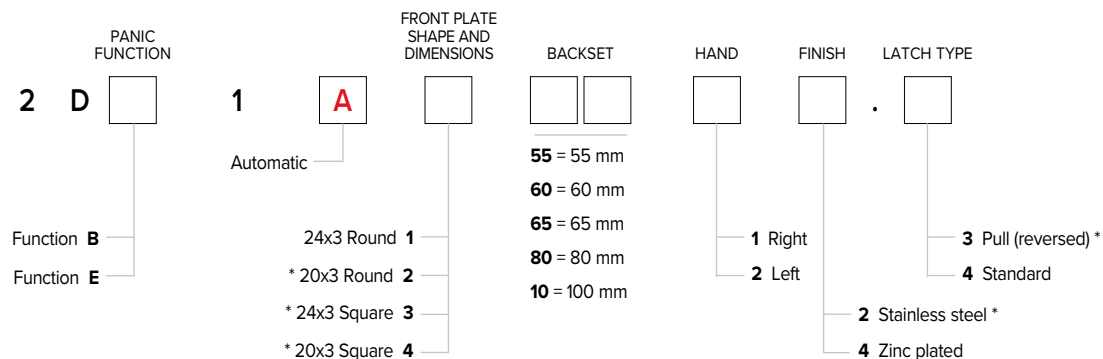
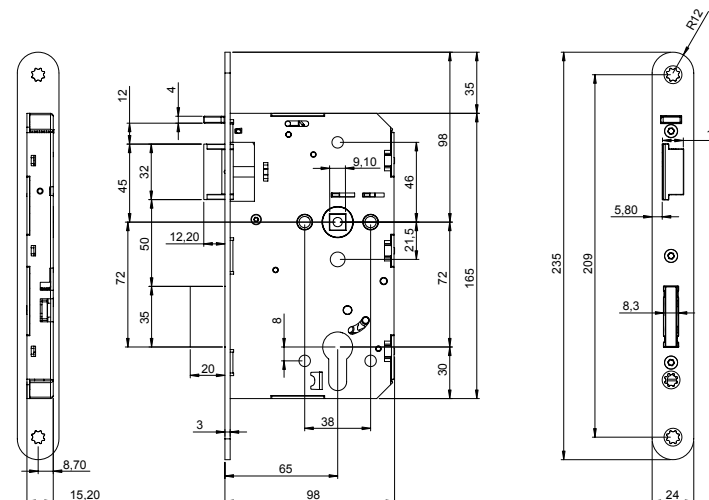

* Versions on request

1NCA Smart





A new range of multistandard readers

INCA Smart Readers is an innovative range of multi-standard, wall-mounted and weatherproof readers of ISEO Connected products line, designed for access management in residential and light commercial buildings. These readers can be easily installed and can manage internal doors but also outdoor gates since they have the IP66 certification.

Elegant in every situation

All INCA Smart Readers combine sleek and minimalist design with premium and durable materials, which is well suited to different environments. Experience the perfect blend of elegance and reliability, elevating your security measures to new heights and unlocking your freedom to move.

FINISH

-  Technopolymer
-  Glass

COLOR

-  Glossy black

Product's functions

- Memorize up to 300 users credentials
- Records the last 1000 events
- Wake up by RFID card detection or phone Bluetooth® (patented)
- Low energy consumption device
- Real Time Clock/Calendar
- Light and acoustic signals
- Permanently open mode (office mode) without no extra battery consumption
- Block the Standard Users allowing access only to VIP users
- Programming and software updates by ARGO App on iOS and Android devices

Go to page

MODELS

- Mullion Lockbus p. 19
- Mullion Relay p. 20
- Mullion 485 p. 21
- Mullion Keyboard Lockbus p. 22
- Mullion Keyboard Relay p. 23
- Mullion Keyboard 485 p. 24
- Cable Free RFID p. 25
- Cable Free Keyboard p. 26
- Cable Free Finger p. 27
- Standard RFID p. 28
- Standard Keyboard p. 29
- Standard Finger p. 30

ENVIRONMENTAL CHARACTERISTICS

- IP66
- Max. 95% without condensing

CREDENTIALS

- Badge
- Keyfob
- Bracelet
- Smartphone
- Apple Watch

COMMUNICATION INTERFACE

- RFID ISO14443B/MIFARE ISO14443A
- Bluetooth® Low Energy 5.1

CERTIFICATIONS

- Compliance to RED, European and UK directives concerning radio equipment regulations

1NCA Smart

Selection guide

1NCA Smart readers are ISEO's new credential readers characterised by an elegant and contemporary design suitable for outdoor installation (IP66). They are available in various models to meet different installation and functional requirements.

ORDER THE PRODUCT IN A FEW STEPS

1

Choose the 1NCA Smart Reader model suitable for your application and click in the column on the right:

Mullion Relay and Mullion Keyboard Relay

Devices with onboard relays for operating directly on electromechanical gates.

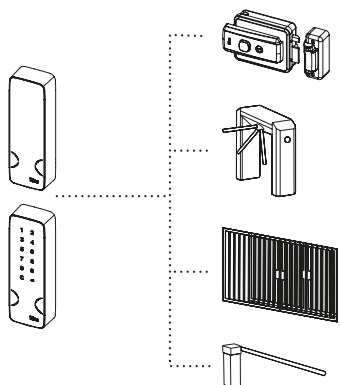

Mullion Lockbus and Mullion Keyboard Lockbus

Lockbus devices for operating electromechanical gates in combination with the Actuator for electromechanical locks. Suitable for replacing the ISEO's Stylos Smart reader.

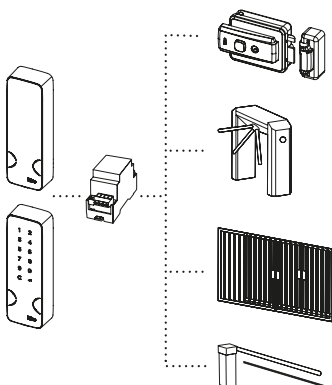

Standard and Mullion 485

RS485 devices for operating doors with ISEO Multiblindo Smart locks or Door Controller Smart.

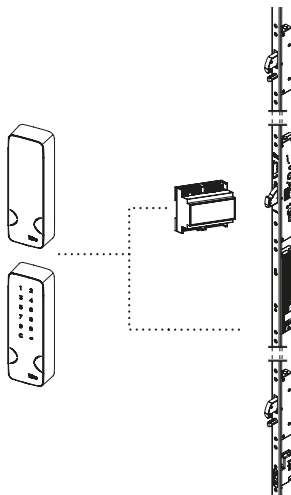

Cable Free RFID, Keyboard and Finger

Battery-powered devices that can be paired via Bluetooth to any ISEO Connected Smart device (Libra X, Aries, MA1A, Relay...), in order to increase their usable credentials.

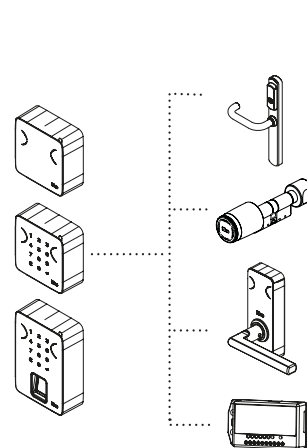

2

Optional.

Choose accessories to complete the system.

Go to page

SELECTION GUIDE

MODELS

- Mullion Lockbus p. 19
- Mullion Relay p. 20
- Mullion 485 p. 21
- Mullion Keyboard Lockbus p. 22
- Mullion Keyboard Relay p. 23
- Mullion Keyboard 485 p. 24
- Cable Free RFID p. 25
- Cable Free Keyboard p. 26
- Cable Free Finger p. 27
- Standard RFID p. 28
- Standard Keyboard p. 29
- Standard Finger p. 30

1NCA Smart Mullion Lockbus

CREDENTIAL READER RFID/BLUETOOTH®, WITH LOCKBUS CONNECTION

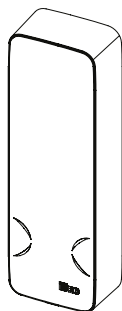

Technical features

FIRMWARE
ARGO

POWER UNIT
9÷24 Vdc (1W)
Automatic low power mode max 0,4mW
Internal CR2032 3V Lithium battery for RTC (real time clock) backup

ALERTS
- Led 3-colour series green, red, blue
- Multi-frequency buzzer

PRODUCT COMPATIBILITY
- Device with Lockbus interface. Suitable as a replacement of Stylos Smart, to couple with the electric lock actuator (5E2501)

MOUNTING
- Wall mounted

ENVIRONMENTAL FEATURES
- IP66
- H.R. max. 95% without condensing

WORKING TEMPERATURE
-20°C ÷ +60°C

STORAGE TEMPERATURE
-20°C ÷ +70°C

PACKAGE
1 reader, 1 fixing bracket, Torx T8 key, 1 x Fixing bracket Torx screw (M2,5x5), instruction manual,
2 x Screws (3,5x25 countersunk head) and wall plugs (5x25),
Spacer with screws included (cod. 0000IS00354)

ACCESSORIES (NOT INCLUDED)
- Electric lock actuator (cod. 5E2501)
- Power supply 24Vdc 1.5 A power supply (cod. 5E3506)





code **5E152315**

 Accessories

DIMENSIONS

- Height: 146 mm
- Width: 48 mm
- Depth: 26 mm

ONLINE CONTENT

-  Web page
-  Data sheet
-  Leaflet
-  User manual
-  Installation guide
-  Specifications

1NCA Smart Mullion Relay

CREDENTIAL READER RFID/BLUETOOTH®,
WITH BUILT IN RELAY

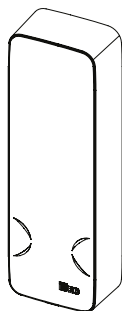

Technical features

FIRMWARE
ARGO

POWER UNIT
9÷24 Vdc (1W)
Automatic low power mode max 0,4mW
Internal CR2032 3V Lithium battery for RTC (real time clock) backup

ALERTS
- Led 3-colour series green, red, blue
- Multi-frequency buzzer

MOUNTING
- Wall mounted

ENVIRONMENTAL FEATURES
- IP66
- H.R. max. 95% without condensing

WORKING TEMPERATURE
-20°C ÷ +60°C

STORAGE TEMPERATURE
-20°C ÷ +70°C

PACKAGE

1 reader, 1 fixing bracket, Torx T8 key, 1 x Fixing bracket Torx screw (M2,5x5), instruction manual,
2 x Screws (3,5x25 countersunk head) and wall plugs (5x25)

ACCESSORIES (NOT INCLUDED)

- Spacer with screws (cod. 0000IS00354)
- Power supply 24Vdc 1.5 A power supply (cod. 5E3506)

code 5E152415



DIMENSIONS

- Height: 146 mm
- Width: 48 mm
- Depth: 26 mm

ONLINE CONTENT

 Web page

 User manual

 Data sheet

 Installation guide

 Leaflet

 Specifications

1NCA Smart Mullion 485

CREDENTIAL READER RFID/BLUETOOTH®,
WITH RS485 CONNECTION

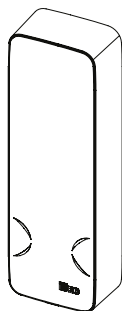

Technical features

FIRMWARE
ARGO

POWER UNIT
9÷24 Vdc (1W)
Automatic low power mode max 0,4mW
Internal CR2032 3V Lithium battery for RTC (real time clock) backup

ALERTS
- Led 3-colour series green, red, blue
- Multi-frequency buzzer

PRODUCT COMPATIBILITY
- Can be used in combination with ISEO devices
with RS485 interface

MOUNTING
- Wall mounted

ENVIRONMENTAL FEATURES
- IP66
- H.R. max. 95% without condensing

WORKING TEMPERATURE
-20°C ÷ +60°C

STORAGE TEMPERATURE
-20°C ÷ +70°C

PACKAGE
1 reader, 1 fixing bracket, Torx T8 key, 1 x Fixing bracket Torx screw (M2,5x5), instruction manual,
2 x Screws (3,5x25 countersunk head) and wall plugs (5x25)



ACCESSORIES (NOT INCLUDED)
- Spacer with screws (cod. 0000IS00354)
- Power supply 24Vdc 1.5 A power supply (cod. 5E3506)



code 5E152212



DIMENSIONS
- Height: 146 mm
- Width: 48 mm
- Depth: 26 mm

ONLINE CONTENT

 Web page
 Data sheet
 Leaflet

 User manual
 Installation guide
 Specifications

INCA Smart Mullion Keyboard Lockbus

CREDENTIAL READER WITH KEYBOARD, RFID
CONTACTLESS MULTISTANDARD, BLUETOOTH®
WITH LOCKBUS CONNECTION

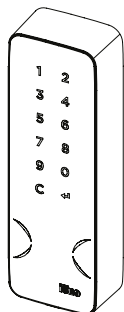

Technical features

FIRMWARE
ARGO

POWER UNIT
9÷24 Vdc (1W)
Automatic low power mode max 0,4mW
Internal CR2032 3V Lithium battery for RTC (real time clock) backup

ALERTS
- Led 3-colour series green, red, blue
- Multi-frequency buzzer

PRODUCT COMPATIBILITY
- Device with Lockbus interface. Suitable as a replacement of Stylos Smart, to couple with the electric lock actuator (5E2501)

MOUNTING
- Wall mounted

ENVIRONMENTAL FEATURES
- IP66
- H.R. max. 95% without condensing

WORKING TEMPERATURE
-20°C ÷ +70°C

STORAGE TEMPERATURE
-25°C ÷ +75°C

PACKAGE
1 reader, 1 fixing bracket, Torx T8 key, 1 x Fixing bracket Torx screw (M2,5x5), instruction manual,
2 x Screws (3,5x25 countersunk head) and wall plugs (5x25),
spacer with screws (cod. 0000IS00354)

ACCESSORIES (NOT INCLUDED)
- Electric lock actuator (cod. 5E2501)
- Power supply 24Vdc 1.5 A power supply (cod. 5E3506)

code **5E152325**



DIMENSIONS

- Height: 146 mm
- Width: 48 mm
- Depth: 26 mm

ONLINE CONTENT

-  Web page
-  Data sheet
-  Leaflet
-  User manual
-  Installation guide
-  Specifications

1NCA Smart Mullion Keyboard Relay

CREDENTIAL READER WITH KEYBOARD, RFID CONTACTLESS MULTISTANDARD, BLUETOOTH®, WITH BUILT IN RELAY

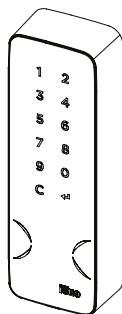

Technical features

FIRMWARE
ARGO

POWER UNIT
9÷24 Vdc (1W)
Automatic low power mode max 0,4mW
Internal CR2032 3V Lithium battery for RTC (real time clock) backup

ALERTS
- Led 3-colour series green, red, blue
- Multi-frequency buzzer

MOUNTING
- Wall mounted

ENVIRONMENTAL FEATURES
- IP66
- H.R. max. 95% without condensing

WORKING TEMPERATURE
-20°C ÷ +70°C

STORAGE TEMPERATURE
-25°C ÷ +75°C

PACKAGE
1 reader, 1fixing bracket, Torx T8 key, 1 x Fixing bracket Torx screw (M2,5x5), instruction manual, 2 x Screws (3,5x25 countersunk head) and wall plugs (5x25).

ACCESSORIES (NOT INCLUDED)
- Spacer with screws (cod. 0000IS00354)
- Power supply 24Vdc 1.5 A power supply (cod. 5E3506)

code **5E152425**



DIMENSIONS

- Height: 146 mm
- Width: 48 mm
- Depth: 26 mm

ONLINE CONTENT

-  Web page
-  Data sheet
-  Leaflet
-  User manual
-  Installation guide
-  Specifications

INCA Smart Mullion Keyboard 485

CREDENTIAL READER RFID/BLUETOOTH® WITH KEYBOARD, WITH RS485 CONNECTION

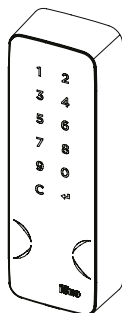

Technical features

FIRMWARE
ARGO

POWER UNIT
9÷24 Vdc (1W)
Automatic low power mode max 0,4mW
Internal CR2032 3V Lithium battery for RTC (real time clock) backup

ALERTS
- Led 3-colour series green, red, blue
- Multi-frequency buzzer

PRODUCT COMPATIBILITY
- Can be used in combination with ISEO devices with RS485 interface

MOUNTING
- Wall mounted

ENVIRONMENTAL FEATURES
- IP66
- H.R. max. 95% without condensing

WORKING TEMPERATURE
-20°C ÷ +60°C

STORAGE TEMPERATURE
-20°C ÷ +70°C

PACKAGE
1 reader, 1 fixing bracket, Torx T8 key, 1 x Fixing bracket Torx screw (M2,5x5), instruction manual,
2 x Screws (3,5x25 countersunk head) and wall plugs (5x25)

ACCESSORIES (NOT INCLUDED)
- Spacer with screws (cod. 0000IS00354)
- Power supply 24Vdc 1.5 A power supply (cod. 5E3506)



code 5E152225



DIMENSIONS

- Height: 146 mm
- Width: 48 mm
- Depth: 26 mm

ONLINE CONTENT

-  Web page
-  Data sheet
-  Leaflet
-  User manual
-  Installation guide
-  Specifications

1NCA Smart Cable Free RFID

CABLE FREE RFID AND BLUETOOTH®, BATTERY OPERATED, CAN BE COUPLED TO ANY ISEO CONNECTED SMART LOCKING DEVICE

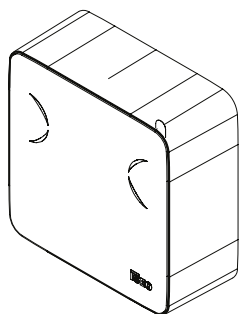

code **5E1511155**

DIMENSIONS

- Height: 82 mm
- Width: 82 mm
- Depth: 26 mm

Technical features

FIRMWARE
ARGO

POWER UNIT
4 Alkaline AA batteries
Max Power consumption 1W
Automatic low power mode max 0,4mW

ESTIMATED BATTERY LIFE
Up to 2 years, up to 20.000 opening.
The figure is dependent on the mode and environment of use and the options activated.

ALERTS
- Led 3-colour series green, red, blue
- Multi-frequency buzzer

MOUNTING
- Wall mounted

ENVIRONMENTAL FEATURES
- IP66
- H.R. max. 95% without condensing

WORKING TEMPERATURE
-20°C ÷ +60°C

STORAGE TEMPERATURE
-20°C ÷ +70°C

PACKAGE
1 reader, 4 Alkaline AA batteries, 1 fixing bracket, Torx T8 key, 1 x Fixing bracket Torx screw (M2,5x5), instruction manual, 2 x Screws (3,5x25 countersunk head) and wall plugs (5x25).

ONLINE CONTENT

- | | |
|--|--|
|  Web page |  User manual |
|  Data sheet |  Installation guide |
|  Leaflet |  Specifications |

1NCA Smart Cable Free Keyboard

CABLE FREE RFID AND BLUETOOTH® READER, BATTERY OPERATED, FEATURING A CAPACITIVE NUMERIC KEYBOARD, CAN BE COUPLED TO ANY ISEO CONNECTED SMART LOCKING DEVICE

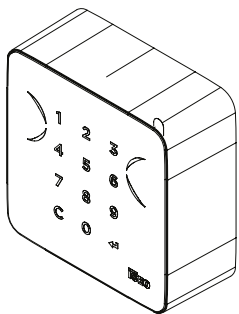

code 5E1511255

DIMENSIONS

- Height: 82 mm
- Width: 82 mm
- Depth: 26 mm

Technical features

FIRMWARE
ARGO

POWER UNIT
4 Alkaline AA batteries
Max Power consumption 1W
Automatic low power mode max 0,4mW

ESTIMATED BATTERY LIFE
Up to 2 years, up to 20.000 opening.
The figure is dependent on the mode and environment of use and the options activated.

ALERTS
- Led 3-colour series green, red, blue
- Multi-frequency buzzer

MOUNTING
- Wall mounted

ENVIRONMENTAL FEATURES
- IP66
- H.R. max. 95% without condensing

WORKING TEMPERATURE
-20°C ÷ +60°C

STORAGE TEMPERATURE
-25°C ÷ +70°C

PACKAGE
1 reader, 4 Alkaline AA batteries, 1 fixing bracket, Torx T8 key, 1 x Fixing bracket Torx screw (M2,5x5), instruction manual, 2 x Screws (3,5x25 countersunk head) and wall plugs (5x25).

ONLINE CONTENT

-  Web page
-  Data sheet
-  Leaflet
-  User manual
-  Installation guide
-  Specifications

1NCA Smart Cable Free Finger

CABLE FREE RFID AND BLUETOOTH® READER, BATTERY OPERATED, FEATURING A CAPACITIVE NUMERIC KEYBOARD AND A FINGERPRINT READER, CAN BE COUPLED TO ANY ISEO CONNECTED SMART LOCKING DEVICE

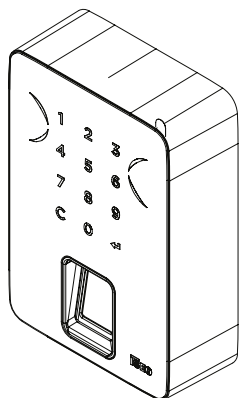

code 5E1511355

DIMENSIONS

- Height: 120 mm
- Width: 82 mm
- Depth: 35 mm

Technical features

FIRMWARE
ARGO

POWER UNIT
4 Alkaline AA batteries
Max Power consumption 1W
Automatic low power mode max 0,4mW

ESTIMATED BATTERY LIFE
Up to 2 years, up to 20.000 opening.
The figure is dependent on the mode and environment of use and the options activated.

ALERTS
- Led 3-colour series green, red, blue
- Multi-frequency buzzer

MOUNTING
- Wall mounted

ENVIRONMENTAL FEATURES
- IP66
- H.R. max. 95% without condensing

WORKING TEMPERATURE
-20°C ÷ +60°C

STORAGE TEMPERATURE
-25°C ÷ +70°C

PACKAGE
1 reader, 4 Alkaline AA batteries, 1 fixing bracket, Torx T8 key, 1 x Fixing bracket Torx screw (M2,5x5), instruction manual, 2 x Screws (3,5x25 countersunk head) and wall plugs (5x25).

ONLINE CONTENT

- | | |
|--|--|
|  Web page |  User manual |
|  Data sheet |  Installation guide |
|  Leaflet |  Specifications |

1NCA Smart Standard RFID

CREDENTIAL READER RFID/BLUETOOTH®,
WITH RS485 CONNECTION

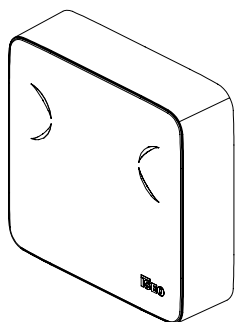

Technical features

FIRMWARE
ARGO

POWER UNIT
9÷24 Vdc - Max power consumption = 1W

ALERTS
- Led 3-colour series green, red, blue
- Multi-frequency buzzer

PRODUCT COMPATIBILITY
- Can be used in combination with ISEO devices with RS485 interface

MOUNTING
- Wall mounted

ENVIRONMENTAL FEATURES
- IP66
- H.R. max. 95% without condensing

WORKING TEMPERATURE
-20°C ÷ +60°C

STORAGE TEMPERATURE
-20°C ÷ +70°C

PACKAGE
1 1NCA reader, 1 fixing bracket, Torx T8 key, 1 x Fixing bracket Torx screw (M2,5x5), instruction manual, 2 x Screws (3,5x25 countersunk head) and wall plugs (5x25)

ACCESSORIES (NOT INCLUDED)
- Spacer with screws (cod. 0000IS00355)
- Power supply 24Vdc 1.5 A power supply (cod. 5E3506)

code **5E1512152**

 Accessories

DIMENSIONS

- Height: 82 mm
- Width: 82 mm
- Depth: 23,5 mm

ONLINE CONTENT

-  Web page
-  Data sheet
-  Leaflet
-  User manual
-  Installation guide
-  Specifications

1NCA Smart Standard Keyboard

CREDENTIAL READER WITH NUMERIC KEYBOARD,
RFID/BLUETOOTH®, WITH RS485 CONNECTION

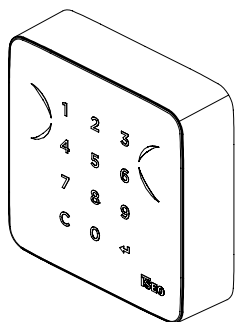

Technical features

FIRMWARE
ARGO

POWER UNIT
9÷24 Vdc - Max power consumption = 1W

ALERTS
- Led 3-colour series green, red, blue
- Multi-frequency buzzer

PRODUCT COMPATIBILITY
- Can be used in combination with ISEO devices with RS485 interface

MOUNTING
- Wall mounted

ENVIRONMENTAL FEATURES
- IP66
- RH 95% max

WORKING TEMPERATURE
-20°C ÷ +60°C

STORAGE TEMPERATURE
-20°C ÷ +70°C

PACKAGE
1 reader, 1 fixing bracket, Torx T8 key, 1 x Fixing bracket Torx screw (M2,5x5), instruction manual, 2 x Screws (3,5x25 countersunk head) and wall plugs (5x25)

ACCESSORIES (NOT INCLUDED)
- Spacer with screws (cod. 0000IS00355)
- Power supply 24Vdc 1.5 A power supply (cod. 5E3506)

code **5E1512255**

 Accessories

DIMENSIONS

- Height: 82 mm
- Width: 82 mm
- Depth: 23,5 mm

ONLINE CONTENT

-  Web page
-  Data sheet
-  Leaflet
-  User manual
-  Installation guide
-  Specifications

1NCA Smart Standard Finger

CREDENTIAL READER WITH NUMERIC KEYBOARD, FINGER READER, RFID/BLUETOOTH®, WITH RS485 CONNECTION

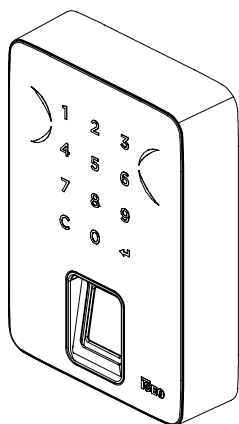

code 5E1512355

 Accessories

DIMENSIONS

- Height: 120 mm
- Width: 82 mm
- Depth: 25,5 mm

Technical features

FIRMWARE

ARGO

POWER UNIT

9÷24 Vdc - Max power consumption = 1W

ALERTS

- Led 3-colour series green, red, blue
- Multi-frequency buzzer

PRODUCT COMPATIBILITY

- Can be used in combination with ISEO devices with RS485 interface

MOUNTING

- Wall mounted

ENVIRONMENTAL FEATURES

- IP66
- RH 95% max

WORKING TEMPERATURE

-20°C ÷ +60°C

STORAGE TEMPERATURE

-20°C ÷ +70°C

PACKAGE

1 reader, 1 fixing bracket, Torx T8 key, 1 x Fixing bracket Torx screw (M2,5x5), instruction manual, 2 x Screws (3,5x25 countersunk head) and wall plugs (5x25)

ACCESSORIES (NOT INCLUDED)

- Spacer with screws (cod. 0000IS00356)
- Power supply 24Vdc 1.5 A power supply (cod. 5E3506)

ONLINE CONTENT

 Web page

 User manual

 Data sheet

 Installation guide

 Leaflet

 Specifications

1NCA Smart

Accessories

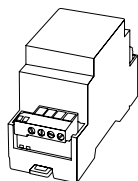

ELECTRIC LOCK ACTUATOR
 1 relay + 1 booster.
 3 inputs (1 digital, 1 analog, 1 digital/ analog)
 Lockbus interface.
 8-30Vdc Power Supply
 DIN35 rail mounting.
 Package: 1 actuator, instruction manual.

1 5E2501

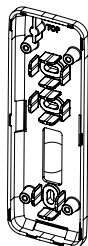

SPACER WITH SCREWS
 2 x Screws (3,5x25 flat-head)
 4 x Screws (3x8)

For Mullion

1 0000IS00354

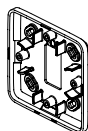

For standard RFID and keyboard

1 0000IS00355

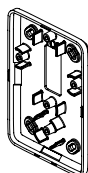

For standard finger

1 0000IS00356

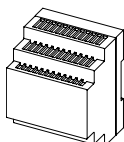

POWER SUPPLY UNIT 24Vdc - 70W
 Input 120-230Vac. Output 24Vdc 1,5A.
 DIN35 rail mounting.
 Package: 1 Power Supply, instruction manual

1 5E3506

Aries Smart 2.1



Make your door Smart

The installation flexibility and simplicity make it the perfect solution for community and residential access control (shopping malls, industries, public and private offices, schools and universities, hospitals and retired hostels, residences and hotels, etc.).

For many applications

Aries electronic trim set can be fit on most doors. It is conceived to be used also with the majority of mechanical locks, for the utmost installation flexibility. The battery operation and cableless technology makes Aries the perfect solution for access management, ensuring utmost flexibility and low installation costs both on new and existing doors.

FINISH

■ Stainless

Product's functions

- Handle movement detection
- Emergency mechanical key detection
- Privacy signal
- Memorize up to 300 users credentials
- Records the last 1000 events
- Battery-operated device with charge status detection
- Wake up by RFID card detection or phone Bluetooth® (patented)
- Low energy consumption device
- Real Time Clock/Calendar
- Light and acoustic signals
- Permanently open mode (office mode) without no extra battery consumption
- Block the Standard Users allowing access only to VIP users
- Programming and software updates by ARGO App on iOS and Android devices

Go to page

MODELS

- Standard p. 34
- For panic devices p. 35
- For custom handles p. 36
- For custom handles for panic devices p. 37
- For DIN lock p. 38
- For fire locks p. 39
- For Premi Apri Meroni locks p. 40

ENVIRONMENTAL CHARACTERISTICS

- IP54
- IP55 with resistance to salty atmosphere

CREDENTIALS

- Badge
- Keyfob
- Bracelet
- Smartphone
- Apple Watch

COMMUNICATION INTERFACE

- RFID ISO14443B/MIFARE ISO14443A
- Bluetooth® Low Energy 5.1

CERTIFICATIONS

- EN 179 certification available in combination with specific locks
- EN 1125 certification available in combination with specific panic devices and locks

Aries Smart 2.1

Selection guide

The Aries electronic handle is available in different versions to suit the customers' needs and the characteristics of the doors on which it is to be installed. The articles required for correct installation are various and must be chosen from the options available both according to the characteristics and dimensions of the door and to the specific usage requirements.

To ensure the correctness and completeness of the order, below is a guide for choosing the various articles that make up the set for each door.

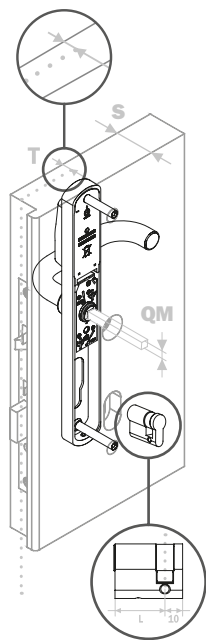

ORDER THE PRODUCT IN A FEW STEPS

1

Check the **type and dimensions of the door** (in case of handle replacement on existing door)

3

Compose the necessary **spindle and screws kit** and check whether an **adapter plate kit is required** (for panic devices and DIN locks).

[Choose from menu](#)

[Spindle and screws kit](#)

[Adapter plate kit](#)

[Other accessories](#)

2

Choose the Aries Smart handle's model **in the right column**, generating the code thanks to the configurator on the product page

4

Optional.

Choose a **lock to match** from those available.

[Go to page](#)

Go to page

SELECTION GUIDE

MODELS

- Standard p. 34
- For panic devices p. 35
- For custom handles p. 36
- For custom handles for panic devices p. 37
- For DIN lock p. 38
- For fire locks p. 39
- For Premi Apri Meroni locks p. 40

Aries Smart 2.1 Standard

ELECTRONIC TRIM RFID/BLUETOOTH® SET STANDARD

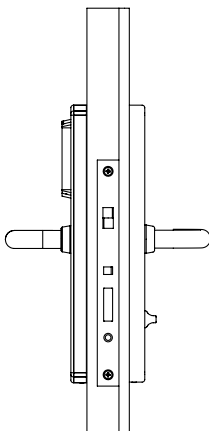

Technical features

FIRMWARE
ARGO

RELEASE
2.1

POWER UNIT
2 alkaline batteries 1.5V type AA

ESTIMATED BATTERY LIFE
Up to 2 years, up to 20.000 opening. The figure is dependent on the mode and environment of use and the options activated.

ALERTS
- LEDs: 1 Green, 1 Red
- Multi-frequency buzzer

PRODUCT COMPATIBILITY
- Can be fit on any door (wooden, aluminium, metal, PVC and so on)
- Door thickness 40 - 85 mm (with standard accessories), 85 - 120 mm (with special accessories)
- Suitable for use fire/smoke resisting door assemblies
- 7, 8 or 9 (*) mm handle follower. Center distance follower/cylinder 70, 72, 85, 88 and 92 mm
- Backset: 25 mm minimum, if using nylon underplate to cover holes on door backset minimum 40 mm. European profile cylinder hole
- Latchbolt only or automatic deadbolt function
- Max handle rotation angle 40°

(*) with adaptor

MOUNTING
- On door

ENVIRONMENTAL FEATURES
- IP54
- IP55 with resistance to salty atmosphere

WORKING TEMPERATURE
-20°C ÷ +60°C

STORAGE TEMPERATURE
-25°C ÷ +75°C

PACKAGE
1 trim (pair), 2 batteries, 2 mm hex key, instruction manual.
NOTE: Handle follower and fixing screws set, mechanical override cylinder and mechanical lock not included.

ACCESSORIES (NOT INCLUDED)
- Handle follower and screws set (mandatory)
- Override cylinder
- Override keys set
- Underplate
- Lock

 Code configurator

 Accessories

DIMENSIONS

- Plate width: 38 mm
- Plate length: 294 mm
- Plate thickness: 17 mm
- Handle length: 131 mm from plate center

Weight
1530 g

ONLINE CONTENT

 Web page

 User manual

 Maintenance manual

 Data sheet

 Installation guide

 Leaflet

 Specifications

Aries Smart 2.1 For panic devices

ELECTRONIC TRIM RFID/BLUETOOTH® SET FOR PANIC DEVICES

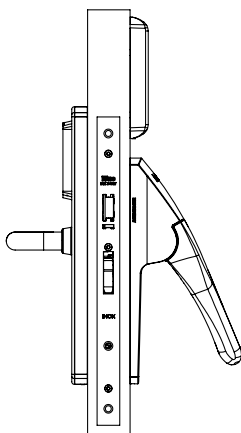

Technical features

FIRMWARE

ARGO

RELEASE

2.1

POWER UNIT

2 alkaline batteries 1.5V type AA

ESTIMATED BATTERY LIFE

Up to 2 years, up to 20.000 opening. The figure is dependent on the mode and environment of use and the options activated.

ALERTS

- LEDs: 1 Green, 1 Red
- Multi-frequency buzzer

PRODUCT COMPATIBILITY

- Can be fit on any door (wooden, aluminium, metal, PVC and so on)
- Door thickness 40 - 85 mm (with standard accessories), 85 - 120 mm (with special accessories)
- Suitable for use fire/smoke resisting door assemblies
- 7, 8 or 9 (*) mm handle follower. Center distance follower/cylinder 70, 72, 85, 88 and 92 mm
- Backset: 25 mm minimum, if using nylon underplate to cover holes on door backset minimum 40 mm. European profile cylinder hole
- Latchbolt only or automatic deadbolt function
- Max handle rotation angle 40°

(*) with adaptor

MOUNTING

- On door

ENVIRONMENTAL FEATURES

- IP54
- IP55 with resistance to salty atmosphere

WORKING TEMPERATURE

-20°C ÷ +60°C

STORAGE TEMPERATURE

-25°C ÷ +75°C

PACKAGE

1 trim, 1 battery holder, 2 batteries, 2 mm hex key, instruction manual.

NOTE: Handle follower and fixing screws set, adapter kit plate, mechanical override cylinder and mechanical lock not included.

ACCESSORIES (NOT INCLUDED)

- Handle follower and screws set (mandatory)
- Override cylinder
- Override keys set
- Underplate
- Lock
- Adapter plate kit for panic devices installation

 Code configurator

 Accessories

DIMENSIONS

- Plate width: 38 mm
- Plate length: 294 mm
- Plate thickness: 17 mm
- Handle length: 131 mm from plate center

Weight
1530 g

ONLINE CONTENT

 Web page

 User manual

 Maintenance manual

 Data sheet

 Installation guide

 Leaflet

 Specifications

Aries Smart 2.1 For custom handles

ELECTRONIC TRIM RFID/BLUETOOTH® SET FOR CUSTOM HANDLES

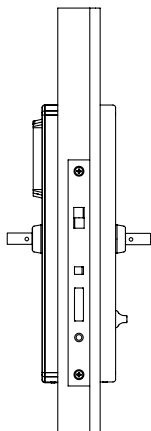

Technical features

FIRMWARE
ARGO

RELEASE
2.1

POWER UNIT
2 alkaline batteries 1.5V type AA

ESTIMATED BATTERY LIFE
Up to 2 years, up to 20.000 opening. The figure is dependent on the mode and environment of use and the options activated.

ALERTS
- LEDs: 1 Green, 1 Red
- Multi-frequency buzzer

PRODUCT COMPATIBILITY
- Can be fit on any door (wooden, aluminium, metal, PVC and so on)
- Door thickness 40 - 85 mm (with standard accessories), 85 - 120 mm (with special accessories)
- Suitable for use fire/smoke resisting door assemblies
- 7, 8 or 9 (*) mm handle follower. Center distance follower/cylinder 70, 72, 85, 88 and 92 mm
- Backset: 25 mm minimum, if using nylon underplate to cover holes on door backset minimum 40 mm. European profile cylinder hole
- Latchbolt only or automatic deadbolt function
- Max handle rotation angle 40°

(*) with adaptor

MOUNTING
- On door

ENVIRONMENTAL FEATURES
- IP54
- IP55 with resistance to salty atmosphere

WORKING TEMPERATURE
-20°C ÷ +60°C

STORAGE TEMPERATURE
-25°C ÷ +75°C

PACKAGE
Industrial Packaging: 10 trims (pairs), 20 batteries, 2 mm hex key, instruction manual.

NOTE:
- handles, handle follower and fixing screws set, mechanical override cylinder and mechanical lock not included.
- For custom handle specifications, please see the corresponding document on iseo.com

ACCESSORIES (NOT INCLUDED)
- Handle follower and screws set (mandatory)
- Override cylinder
- Override keys set
- Underplate
- Lock

 Code configurator

 Accessories

DIMENSIONS

- Plate width: 38 mm
- Plate length: 294 mm
- Plate thickness: 17 mm

Weight
1530 g

ONLINE CONTENT

 Web page

 User manual

 Maintenance manual

 Data sheet

 Installation guide

 Leaflet

 Specifications

Aries Smart 2.1 For custom handles for panic devices

ELECTRONIC TRIM RFID/BLUETOOTH® SET FOR PANIC DEVICES

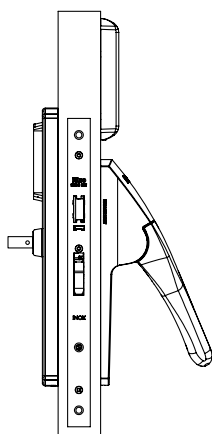

Technical features

FIRMWARE
ARGO

RELEASE
2.1

POWER UNIT
2 alkaline batteries 1.5V type AA

ESTIMATED BATTERY LIFE
Up to 2 years, up to 20.000 opening. The figure is dependent on the mode and environment of use and the options activated.

ALERTS
- LEDs: 1 Green, 1 Red
- Multi-frequency buzzer

PRODUCT COMPATIBILITY
- Can be fit on any door (wooden, aluminium, metal, PVC and so on)
- Door thickness 40 - 85 mm (with standard accessories), 85 - 120 mm (with special accessories)
- Suitable for use fire/smoke resisting door assemblies
- 7, 8 or 9 (*) mm handle follower. Center distance follower/cylinder 70, 72, 85, 88 and 92 mm
- Backset: 25 mm minimum, if using nylon underplate to cover holes on door backset minimum 40 mm. European profile cylinder hole
- Latchbolt only or automatic deadbolt function
- Max handle rotation angle 40°

(*) with adaptor

MOUNTING
- On door

ENVIRONMENTAL FEATURES
- IP54
- IP55 with resistance to salty atmosphere

WORKING TEMPERATURE
-20°C ÷ +60°C

STORAGE TEMPERATURE
-25°C ÷ +75°C

PACKAGE
Industrial Packaging: 10 trims, 10 battery holder, 20 batteries, 2 mm hex key, instruction manual.

NOTE:
- Internal and external handles, handle follower and fixing screws set, mechanical override cylinder and mechanical lock not included.
- For custom handle specifications, please see the corresponding document on iseo.com

ACCESSORIES (NOT INCLUDED)
- Handle follower and screws set (mandatory)
- Override cylinder
- Override keys set
- Underplate
- Lock
- Adapter plate kit for panic devices installation

 Code configurator

 Accessories

DIMENSIONS

- Plate width: 38 mm
- Plate length: 294 mm
- Plate thickness: 17 mm

Weight
1530 g

ONLINE CONTENT

 Web page

 User manual

 Maintenance manual

 Data sheet

 Installation guide

 Leaflet

 Specifications

Aries Smart 2.1 For DIN lock

ELECTRONIC TRIM RFID/BLUETOOTH® SET FOR DIN LOCK

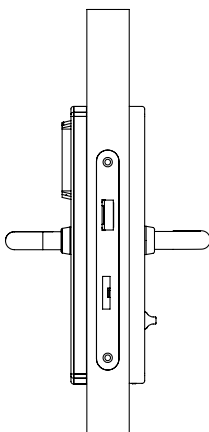

Technical features

FIRMWARE
ARGO

RELEASE
2.1

POWER UNIT
2 alkaline batteries 1.5V type AA

ESTIMATED BATTERY LIFE
Up to 2 years, up to 20.000 opening. The figure is dependent on the mode and environment of use and the options activated.

ALERTS
- LEDs: 1 Green, 1 Red
- Multi-frequency buzzer

PRODUCT COMPATIBILITY
- Can be fit on any door (wooden, aluminium, metal, PVC and so on)
- Door thickness 40 - 85 mm (with standard accessories), 85 - 120 mm (with special accessories)
- Suitable for use fire/smoke resisting door assemblies
- 7, 8 or 9 (*) mm handle follower. Center distance follower/cylinder 70, 72, 85, 88 and 92 mm
- Backset: 25 mm minimum, if using nylon underplate to cover holes on door backset minimum 40 mm. European profile cylinder hole
- Latchbolt only or automatic deadbolt function
- Max handle rotation angle 40°

(*) with adaptor

MOUNTING
- On door

ENVIRONMENTAL FEATURES
- IP54
- IP55 with resistance to salty atmosphere

WORKING TEMPERATURE
-20°C ÷ +60°C

STORAGE TEMPERATURE
-25°C ÷ +75°C

PACKAGE
1 trim (pairs), 2 batteries, 2 mm hex key, instruction manual.
NOTE: handle set, fastener screws, adapter plate kit, emergency cylinder and mechanical lock not included.

ACCESSORIES (NOT INCLUDED)
- Handle follower and screws set (mandatory)
- Override cylinder
- Override keys set
- Underplate
- Lock
- Adapter plate kit for DIN locks installation

 Code configurator

 Accessories

DIMENSIONS

- Plate width: 38 mm
- Plate length: 294 mm
- Plate thickness: 17 mm
- Handle length: 131 mm from plate center

Weight
1530 g

ONLINE CONTENT

 Web page

 User manual

 Maintenance manual

 Data sheet

 Installation guide

 Leaflet

 Specifications

Aries Smart 2.1 For fire locks

ELECTRONIC TRIM RFID/BLUETOOTH® SET FOR FIRE LOCKS

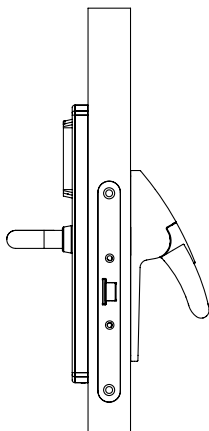

 Code configurator

 Accessories

DIMENSIONS

- Plate width: 38 mm
- Plate length: 294 mm
- Plate thickness: 17 mm
- Handle length: 131 mm from plate center

Weight
1530 g

Technical features

FIRMWARE
ARGO

RELEASE
2.1

POWER UNIT
2 alkaline batteries 1.5V type AA

ESTIMATED BATTERY LIFE
Up to 2 years, up to 20.000 opening. The figure is dependent on the mode and environment of use and the options activated.

ALERTS

- LEDs: 1 Green, 1 Red
- Multi-frequency buzzer

PRODUCT COMPATIBILITY

- Can be fit on any door (wooden, aluminium, metal, PVC and so on)
- Door thickness 40 - 85 mm (with standard accessories), 85 - 120 mm (with special accessories)
- Suitable for use fire/smoke resisting door assemblies
- 7, 8 or 9 (*) mm handle follower. Center distance follower/cylinder 70, 72, 85, 88 and 92 mm
- Backset: 25 mm minimum, if using nylon underplate to cover holes on door backset minimum 40 mm. European profile cylinder hole
- Latchbolt only or automatic deadbolt function
- Max handle rotation angle 40°

(*) with adaptor

ONLINE CONTENT

 Web page

 Data sheet

 Leaflet

 User manual

 Installation guide

 Specifications

MOUNTING
- On door

ENVIRONMENTAL FEATURES

- IP54
- IP55 with resistance to salty atmosphere

WORKING TEMPERATURE
-20°C ÷ +60°C

STORAGE TEMPERATURE
-25°C ÷ +75°C

PACKAGE
1 trim, 1 adapter plate kit, 1 handle set, 2 batteries, fastener screws, 2 mm hex key, instruction manual.
NOTE: mechanical lock and panic devices not included.

ACCESSORIES (NOT INCLUDED)

- Handle follower and screws set (mandatory)
- Override cylinder
- Override keys set
- Underplate
- Lock

Aries Smart 2.1 For Premi Apri Meroni locks

ELECTRONIC TRIM RFID/BLUETOOTH® SET FOR PREMI APRI MERONI LOCKS

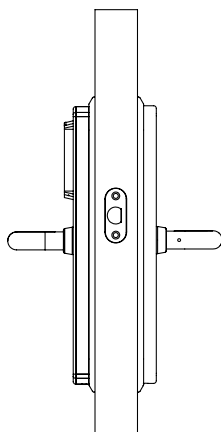

Technical features

FIRMWARE
ARGO

RELEASE
2.1

POWER UNIT
2 alkaline batteries 1.5V type AA

ESTIMATED BATTERY LIFE
Up to 2 years, up to 20.000 opening. The figure is dependent on the mode and environment of use and the options activated.

ALERTS
- LEDs: 1 Green, 1 Red
- Multi-frequency buzzer

PRODUCT COMPATIBILITY
- Can be fit on any door (wooden, aluminium, metal, PVC and so on)
- Door thickness 40 - 85 mm (with standard accessories), 85 - 120 mm (with special accessories)
- Suitable for use fire/smoke resisting door assemblies
- 7, 8 or 9 (*) mm handle follower. Center distance follower/cylinder 70, 72, 85, 88 and 92 mm
- Backset: 25 mm minimum, if using nylon underplate to cover holes on door backset minimum 40 mm. European profile cylinder hole
- Latchbolt only or automatic deadbolt function
- Max handle rotation angle 40°

(*) with adaptor

MOUNTING
- On door

ENVIRONMENTAL FEATURES
- IP54
- IP55 with resistance to salty atmosphere

WORKING TEMPERATURE
-20°C ÷ +60°C

STORAGE TEMPERATURE
-25°C ÷ +75°C

PACKAGE
1 trim (pair) 1 plastic underplate, 2 batteries, 2 mm hex key, instruction manual.
NOTE: handle set and fastener screws, override cylinder and mechanical lock not included.

ACCESSORIES (NOT INCLUDED)
- Handle follower and screws set (mandatory)
- Override cylinder
- Override keys set
- Underplate
- Lock

 Code configurator

 Accessories

DIMENSIONS

- Plate width: 38 mm
- Plate length: 294 mm
- Plate thickness: 17 mm
- Handle length: 131 mm from plate center

Weight
1530 g

ONLINE CONTENT

 Web page

 User manual

 Maintenance manual

 Data sheet

 Installation guide

 Leaflet

 Specifications

Aries Smart 2.1

Accessories

SPINDLE AND SCREWS KIT (1/2) FOR IP54 VERSION

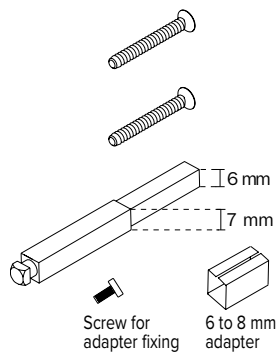

SCREWS AND HANDLE FOLLOWER KIT

2 screws M5 with threadlocking.
 Package: 2 screws, 1 handle follower
 NOTE: Select the right kit depending on door thickness.

QM 7 mm Spindle

Door thickness S from 40 to 55 mm	1	201E074055A
Door thickness S from 55 to 70 mm	1	201E075570A
Door thickness S from 70 to 85 mm	1	201E077085A

QM 8 mm Spindle

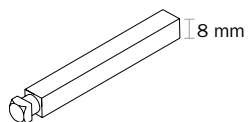

Door thickness S from 40 to 55 mm	1	201E004055A
Door thickness S from 55 to 70 mm	1	201E005570A
Door thickness S from 70 to 85 mm	1	201E007085A
Door thickness MAX 125 mm (to be cut)	1	201E008010A

QM 9 mm Spindle (for fire doors)

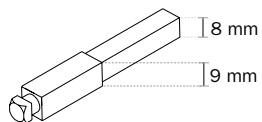

Door thickness S from 40 to 55 mm	1	201E094055A
Door thickness S from 55 to 70 mm	1	201E095570A
Door thickness S from 70 to 85 mm	1	201E097085A
Door thickness S from 85 to 125 mm	1	201E098010A

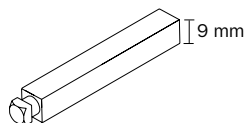

SCREWS AND HANDLE FOLLOWERS KIT

For panic devices installation.
 Followers 9 mm and fixing screws for doors thickness up to 85 mm.
 NOTE: to be cut according to door thickness

	1	201E915570A
--	---	-------------

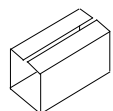

ADAPTER FOR HANDLE FOLLOWER

8 to 9 mm adapter	10	5060000900092
-------------------	----	---------------

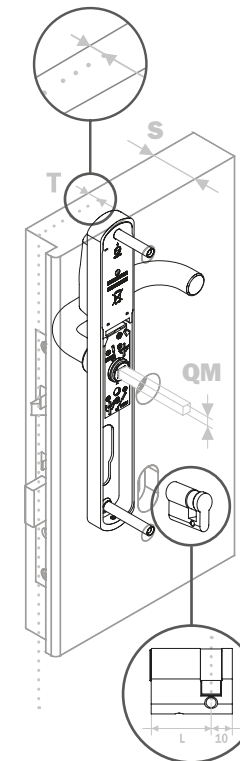

Aries Smart 2.1

Accessories

STAINLESS STEEL SPINDLE AND SCREWS KIT (2/2) FOR IP55 VERSION

SCREWS AND HANDLE FOLLOWER KIT

2 screws M5 with threadlocking.
 Package: 2 screws, 1 handle follower
 NOTE: Select the right kit depending on door thickness.

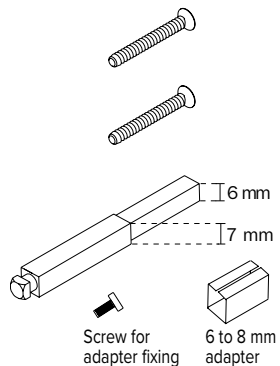

QM 7 mm Spindle

Door thickness S from 40 to 55 mm	1	0000A00244
Door thickness S from 55 to 70 mm	1	0000A00245
Door thickness S from 70 to 85 mm	1	0000A00246

QM 8 mm Spindle

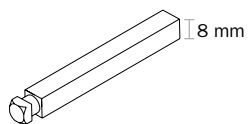

Door thickness S from 40 to 55 mm	1	0000A00234
Door thickness S from 55 to 70 mm	1	0000A00235
Door thickness S from 70 to 85 mm	1	0000A00236
Door thickness MAX 125 mm (to be cut)	1	0000A00237

QM 9 mm Spindle (for fire doors)

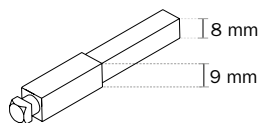

Door thickness S from 40 to 55 mm	1	0000A00238
Door thickness S from 55 to 70 mm	1	0000A00239
Door thickness S from 70 to 85 mm	1	0000A00240
Door thickness S from 85 to 125 mm	1	0000A00241

SCREWS AND HANDLE FOLLOWERS KIT

For panic devices installation.
 Followers 9 mm and fixing screws for doors thickness up to 85 mm.
 NOTE: to be cut according to door thickness

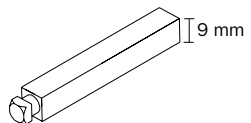

	1	0000A00263
--	---	------------

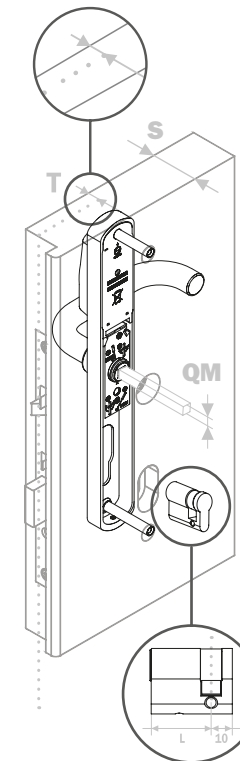

Aries Smart 2.1

Accessories

ADAPTER PLATE KIT

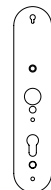

ADAPTER PLATE KIT
 For panic devices installation with series 214* panic lock case (DIN 72 mm center distance).
 Package: 1 adapter plate.

1 529E000040

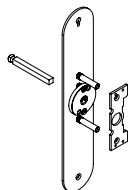

ADAPTER PLATE KIT
 For RIM panic devices Idea Push installation
 Package: plates, fixing screws, accessories.

1 567E0000540

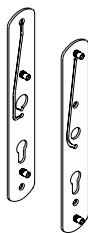

ADAPTER PLATE KIT
 For DIN locks installation
 Package: plates

1 529E080054

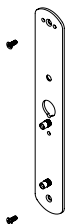

ADAPTER PLATE KIT
 Fire Doors Installation
 Package: 1 plate with 2 screws

1 201E093054A

Aries Smart 2.1

Accessories

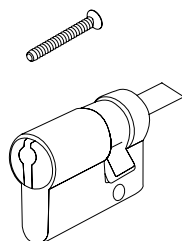

OVERRIDE MECHANICAL CYLINDER

Monoprofile with usage detection plate. High Security ISEO R90 Factory.
Up to 3 mechanical recordings. KA on the same installation. Nickel plated finish. Without keys.
Package: 1 cylinder, 1 fixing screw

VISIBLE CYLINDER		HIDDEN CYLINDER	
$08 < T < 13$	$L = 30 + 10 \text{ mm}$	$17 < T < 27$	$L = 30 + 10 \text{ mm}$
$13 < T < 23$	$L = 40 + 10 \text{ mm}$	$27 < T < 37$	$L = 40 + 10 \text{ mm}$
$23 < T < 33$	$L = 50 + 10 \text{ mm}$	$37 < T < 47$	$L = 50 + 10 \text{ mm}$

S = door thickness (mm)

T = distance between front plate axis of symmetry of mechanical lock and the external door edge

NOTE: Select the right dimension depending on door and lock features.

Override keys to be ordered separately.

Lenght L 30 - 10 mm	1	82RC030A19RF.08
Lenght L 40 - 10 mm	1	82RC040A19RF.08
Lenght L 50 - 10 mm	1	82RC050A19RF.08

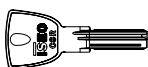

OVERRIDE KEYS KIT

3 R90 keys in sequence.

Property cards.

Package: 3 keys, 2 property cards

	1	80RCKR0F0
--	---	-----------

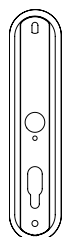

PLASTIC UNDERPLATE

Black plastic underplate to cover up eventually visible key holes.

Dimensions: H=312 mm, L=70 mm.

Package: 1 underplate.

	1	529E00000
--	---	-----------

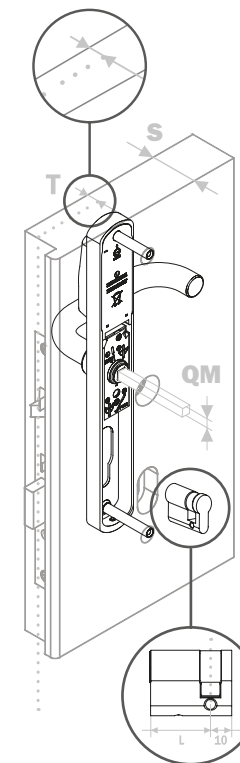

Aries Smart 2.1

Accessories

AESTHETIC EXTERNAL AND INTERNAL COVER

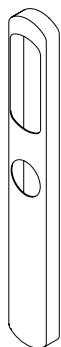

AESTHETIC EXTERNAL COVER
Without cylinder hole in the cover.
Package: 1 cover

Inox	1	561E1120240
------	---	-------------

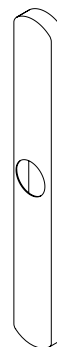

AESTHETIC INTERNAL COVER
Without privacy.
Package: 1 cover

Inox	1	561E1130240
------	---	-------------

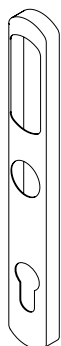

AESTHETIC EXTERNAL COVER
With cylinder hole.
Package: 1 cover

70 mm center distance

Inox	1	561E1420240
------	---	-------------

72 mm center distance

Inox	1	561E1520240
------	---	-------------

85 mm center distance

Inox	1	561E1220240
------	---	-------------

88 mm center distance

Inox	1	561E1620240
------	---	-------------

92 mm center distance

Inox	1	561E1320240
------	---	-------------

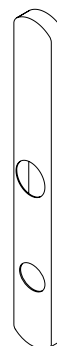

AESTHETIC INTERNAL COVER
With privacy.
Package: 1 cover

Inox	1	561E1330240
------	---	-------------

Aries Smart 2.1

Accessories

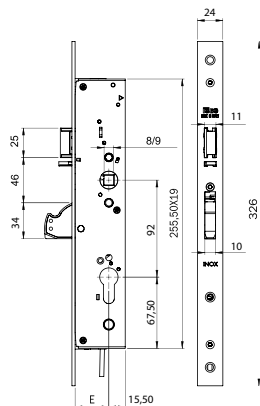

LOCK CAN BE COMBINED (1/3)

MULTIBLINDO EASY EXIT LATERAL.

Automatic lock with emergency function to be used with Aries.
 Locking: deadbolt automatic relocking when the door is closed.
 Opening: latchbolt and deadbolt operated by the handle or the key.
 Center distance 92 mm. The microswitch detects and signals the deadbolt status.
 Right or left latchbolt, non reversible. To be ordered separately: striking plates 03323*.
 Package: 1 lock, instructions.

ONE-PIECE HANDLE FOLLOWER 9 mm
 8/9 mm square spindle code 201E094055A included.

Flat front-plate		Backset mm		
326x24x3	INOX	35 DIN SX	1	7A1A163522S.A9
		35 DIN DX	1	7A1A163522D.A9
		40 DIN SX	1	7A1A164022S.A9
		40 DIN DX	1	7A1A164022D.A9
		45 DIN SX	1	7A1A164522S.A9
		45 DIN DX	1	7A1A164522D.A9
		50 DIN SX	1	7A1A165022S.A9
		50 DIN DX	1	7A1A165022D.A9
		55 DIN SX	1	7A1A165522S.A9
		55 DIN DX	1	7A1A165522D.A9
		60 DIN SX	1	7A1A166022S.A9
		60 DIN DX	1	7A1A166022D.A9
		65 DIN SX	1	7A1A166522S.A9
		65 DIN DX	1	7A1A166522D.A9

ONE-PIECE HANDLE FOLLOWER 8 mm

Flat front-plate		Backset mm		
326x24x3	INOX	35 DIN SX	1	7A1A163522S.A8
		35 DIN DX	1	7A1A163522D.A8
		40 DIN SX	1	7A1A164022S.A8
		40 DIN DX	1	7A1A164022D.A8
		45 DIN SX	1	7A1A164522S.A8
		45 DIN DX	1	7A1A164522D.A8
		50 DIN SX	1	7A1A165022S.A8
		50 DIN DX	1	7A1A165022D.A8
		55 DIN SX	1	7A1A165522S.A8
		55 DIN DX	1	7A1A165522D.A8
		60 DIN SX	1	7A1A166022S.A8
		60 DIN DX	1	7A1A166022D.A8
		65 DIN SX	1	7A1A166522S.A8
		65 DIN DX	1	7A1A166522D.A8

Aries Smart 2.1

Accessories

LOCK CAN BE COMBINED (2/3)

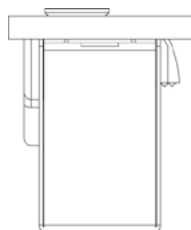

Full-size scale

ADJUSTABLE closed striking plate for CENTRAL LOCK
 MULTIBLINDO EASY.

Material: stainless steel.

With mechanical striker.

Flat front-plate 24x3x220 DIN SX

10 033230

Flat front-plate 24x3x220 DIN DX

10 033231

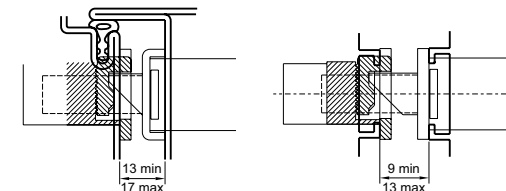
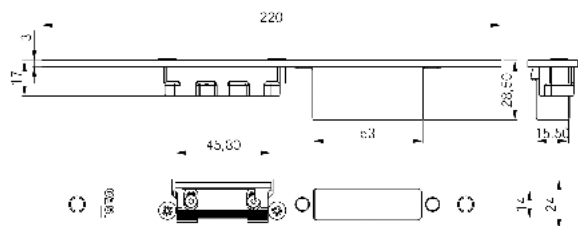

In case the space between the striking plate and the door is greater, it is necessary to use a spacer for the striking plate

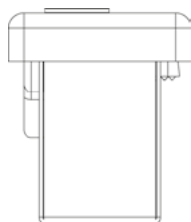

Full-size scale

ADJUSTABLE closed striking plate for CENTRAL LOCK
 MULTIBLINDO EASY.

Material: stainless steel.

With mechanical striker.

U-front plate 24x6x220 DIN SX

10 033232

U-front plate 24x6x220 DIN DX

10 033233

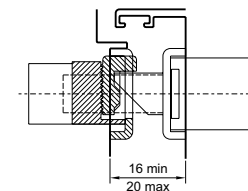
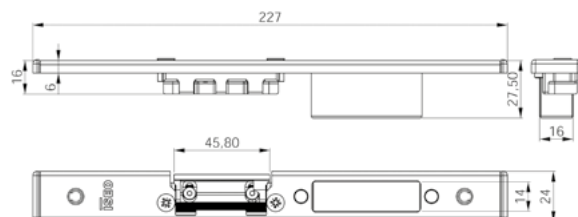

In case the space between the striking plate and the door is greater, it is necessary to use a spacer for the striking plate

Aries Smart 2.1

Accessories

LOCK CAN BE COMBINED (3/3)

PANIC FIRE-RATED SELF-LOCKING LOCK

Panic self-locking lock for fire-resistant doors.

When the leaf is approached, the deadbolt of the lock is automatically engaged.

Internal operation:

The key operates the external handle (function B) and retracts the latch and deadbolt (only with function E).

The panic bar and/or emergency handle always retract the latch and deadbolt.

External operation:

The key enables/disables the handle that recalls the latch and deadbolt (function B).

72 mm center distance. 9 mm sintered steel handle follower set with 30° rotation.

Self-locking 20 mm deadbolt.

Zinc plated front plate (stainless steel option) with round edges (square edges option) 24x3 mm (20x3 mm option). NK sintered steel latch.

Compatible with Euro profile cylinder, with DIN cam to be ordered separately.

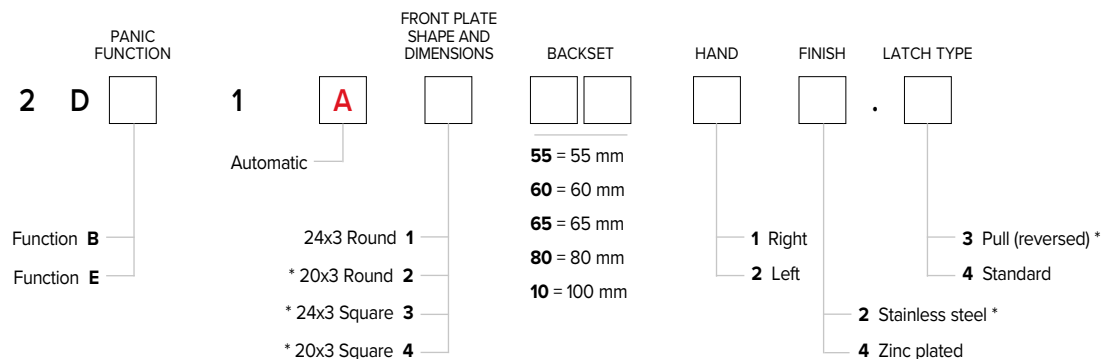
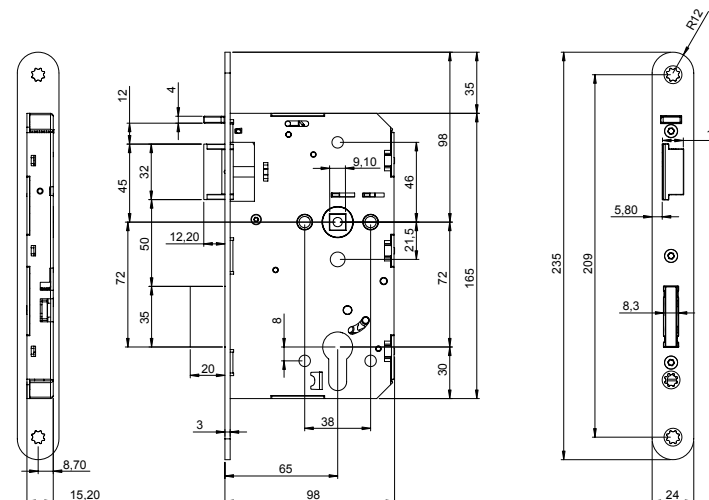

* Versions on request

Smart Locker 2.0



For office, gym, swimming pool

Smart Locker can be installed on a wide range of cabinets and lockers in order to keep people's property safe while they're in the office, the gym, swimming pool, or any other situation where personal belongings need to be temporarily safeguarded.

Automatic locking

By closing the door of the cabinet, Smart Locker will automatically lock.

The Smart Locker is battery powered allowing easy installation in new lockers or retrofit in existing lockers currently operated by keys.

Product's functions

- Automatic locking just pulling the door ajar
- Memorize up to 300 users credentials
- Records the last 1000 events
- Battery-operated device with charge status detection
- Wake up by RFID card detection or phone Bluetooth® (patented)
- Low energy consumption device
- Real Time Clock/Calendar
- Light and acoustic signals
- Permanently open mode (office mode) without no extra battery consumption
- Block the Standard Users allowing access only to VIP users
- Programming and software updates by ARGO App on iOS and Android devices

FINISH

 Technopolymer

COLOR

 Anthracite

ENVIRONMENTAL CHARACTERISTICS

- IP20

CREDENTIALS

- Badge
- Keyfob
- Bracelet
- Smartphone
- Apple Watch

COMMUNICATION INTERFACE

- RFID ISO14443B/MIFARE ISO14443A
- Bluetooth® Low Energy 5.1

Go to page

MODELS

→ [Electronic lock for cabinets](#) p. 50

Smart Locker 2.0 Electronic lock for cabinets

RFID/BLUETOOTH® ELECTRONIC LOCK FOR CABINETS AND LOCKERS

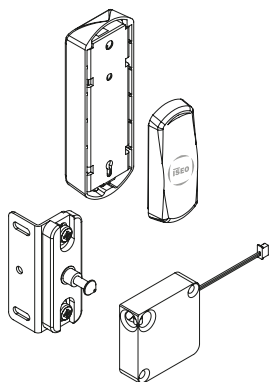

Technical features

FIRMWARE
ARGO

RELEASE
2.0

POWER UNIT
2 lithium batteries 3.6V type AA

ESTIMATED BATTERY LIFE
Up to 2 years, up to 20.000 opening.
The figure is dependent on the mode and environment of use and the options activated.

ALERTS
- LEDs: 1 Green, 1 Red
- Multi-frequency buzzer

PRODUCT COMPATIBILITY
- Smart Locker can be installed on a wide range of cabinets and lockers in order to protect users' belongings while they are in office, gym, swimming pool or in every similar situation where people need to deposit personal items in a secure place

MOUNTING
- On door

ENVIRONMENTAL FEATURES
- IP20

WORKING TEMPERATURE
-20°C ÷ +60°C

STORAGE TEMPERATURE
-25°C ÷ +75°C

PACKAGE
1 RFID reader, 2 batteries, lock with pin latch, fixing screws, instruction manual

ACCESSORIES (NOT INCLUDED)
- Battery (58200000E0360)
- Accessory for electric emergency (0000IS00253)

code **1EL10155**

 Accessories

DIMENSIONS

External dimensions:

- Width: 39 mm
- Height: 86 mm

Internal dimensions:

- Width: 40 mm
- Height: 130 mm

ONLINE CONTENT

 Web page

 Data sheet

 Leaflet

 User manual

 Installation guide

 Specifications

 Accessory for electrical emergency

Smart Locker 2.0

Accessories

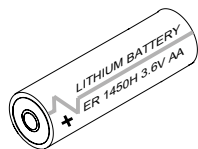

BATTERY
 High current lithium battery
 Size AA, 3.6 Vcc

10 58200000E0360



ACCESSORY FOR ELECTRIC EMERGENCY
 Package: 1 battery holder.
 NOTE: BATTERIES NOT INCLUDED.

1 0000IS00253

Libra X Smart

Go to page

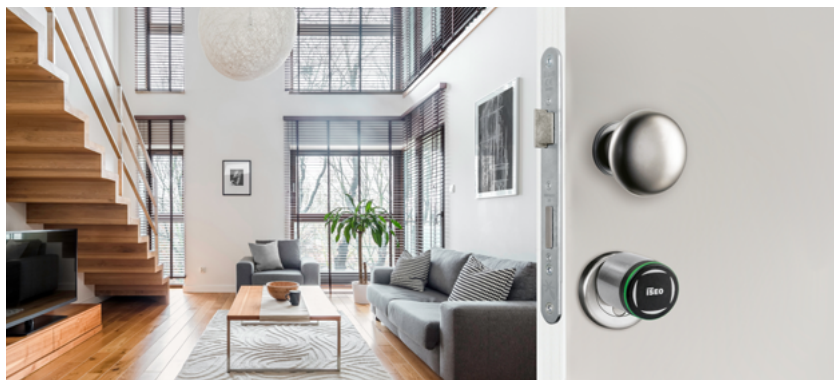

Suitable for different applications

Thanks to its easy and straightforward installation, the Libra X electronic modular cylinder is the ideal universal solution for access control, both for retrofit applications replacing European profile mechanical cylinders and for installations on new doors.

Easy to install

Battery-powered operation and the absence of electrical wiring ensure maximum flexibility and low installation costs, both for new installations and retrofit applications on existing doors.

Product features

- Wake up by RFID card detection or phone (patented)
- Battery-operated device with charge status detection
- Low energy consumption device
- Permanently open mode (office mode) without extra battery consumption
- Memorize up to 300 users credentials
- Records the last 1000 events
- Real Time Clock/Calendar
- Light and acoustic signals
- Programming and software updates by ARGO App on iOS and Android devices
- Block the Standard Users allowing access only to VIP users

FINISH

Stainless

COLOUR

Matt black

Matt white

ENVIRONMENTAL FEATURES

- IP66
- IP67
- IP68
- IP69

ACCESS CREDENTIALS

- Apple Watch
- Badge
- Bracelet
- Keyfob
- Smartphone

COMMUNICATION INTERFACE

- Bluetooth® Low Energy 5.1
- RFID ISO14443B/MIFARE ISO14443A

CERTIFICATIONS

- EN 15684:2020 Standard Duty version 16B40D30 (DESFire Cards)
- EN 15684:2020 Heavy Duty version 16B40D3D (DESFire Cards)
- SKG***for HD (Heavy Duty) version

MODELS

- Standard p. 54
- Premium p. 55
- Half p. 56
- Double p. 57
- Removable reader and Extension plug 16 mm p. 58
- Removable reader and Extension plug 75 mm p. 59
- Dummy-knob p. 60
- Oval Australian p. 61
- Oval Scandinavian p. 62

Libra X Smart

Selection guide

The Libra X electronic modular cylinder represents the ideal and universal solution for access control both for retrofit installations to replace of mechanical European profile cylinders (in addition to the Australian and Scandinavian oval cylinder versions), and for installations on new doors.

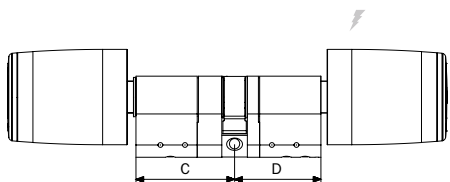

ORDER THE PRODUCT IN A FEW STEPS

1

Check the door type and the dimensions of the cylinder (in the case of replacement on an existing door).

2

Choose the Libra X model in the column on the right, generating the code thanks to the configurator on the product page.

3

Optional.

See accessory sheets for modifications and component replacements.

[Choose from menu](#)

[Pre-assembled modules](#)

[Modular Libra assembled components](#)

[Electronic knob spare parts](#)

[Premium knob cover \(RFID and mechanical version\)](#)

[Standard mechanical knob](#)

[Anti-intrusion accessories](#)

[Assembly/Disassembly tooling kit](#)

[Assembly tooling kit for modular cylinders](#)

[Packaging design](#)

Go to page

SELECTION GUIDE

MODELS

- Standard p. 54
- Premium p. 55
- Half p. 56
- Double p. 57
- Removable reader and Extension plug 16 mm p. 58
- Removable reader and Extension plug 75 mm p. 59
- Dummy-knob p. 60
- Oval Australian p. 61
- Oval Scandinavian p. 62

Libra X Smart Standard

MODULAR CYLINDER WITH EXTERNAL ELECTRONIC RFID/BLUETOOTH® KNOB (FREE ROTATION) AND INTERNAL MECHANICAL KNOB (STANDARD TYPE)

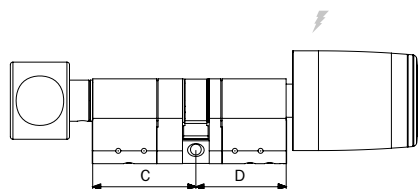

 Code configurator

 Accessories

DIMENSIONS

Electronic knob dimensions:

- External diameter: 36 to 39 mm
- Length: 49 mm

"Standard" mechanical knob dimensions:

- External diameter: 30 mm
- Length: 31 mm

Technical features

FIRMWARE
ARGO

POWER UNIT
13V lithium battery type CR123

ESTIMATED BATTERY LIFE
Up to 2 years, up to 20.000 opening.
The figure is dependent on the mode and environment of use and the options activated.

ALERTS
- LEDs: 1 Green, 1 Red
- Multi-frequency buzzer

PRODUCT COMPATIBILITY
- Compatible with all the mechanical locks equipped with an European profile cylinder hole (EN 1303, DIN 18252)

MOUNTING
- On door

ENVIRONMENTAL FEATURES
- IP66
- IP67
- IP68
- IP69

WORKING TEMPERATURE
-25°C / +65°C

STORAGE TEMPERATURE
-25°C / +65°C

PACKAGE
1 cylinder, 1 battery, fastener screw, 2 mm hex key, instruction sheet.

ACCESSORIES (NOT INCLUDED)

- Pre-assembled modules
- Assembled modular Libra components
- Electronic knob spare parts
- Premium knob covers (RFID and mechanical versions)
- Standard mechanical knob
- Anti-burglary accessories
- Assembly/disassembly tool set
- Installation tools for modular cylinders
- Design packaging

ONLINE CONTENT

 Web page

 User manual

 Warnings

 Data sheet

 Installation guide

 Leaflet

 Specifications

Libra X Smart Premium

MODULAR CYLINDER WITH EXTERNAL ELECTRONIC RFID/BLUETOOTH® KNOB (FREE ROTATION) AND INTERNAL MECHANICAL KNOB (PREMIUM TYPE)

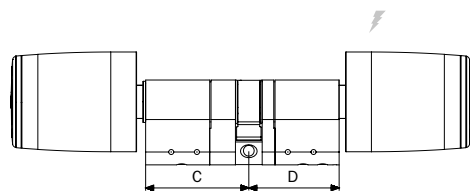

 Code configurator

 Accessories

DIMENSIONS

Electronic knob dimensions:

- External diameter from 36 to 39 mm
- Length: 49 mm

"Premium" mechanical knob dimensions:

- External diameter from 36 to 39 mm
- Length: 49 mm

Technical features

FIRMWARE
ARGO

POWER UNIT
13V lithium battery type CR123

ESTIMATED BATTERY LIFE
Up to 2 years, up to 20.000 opening.
The figure is dependent on the mode and environment of use and the options activated.

ALERTS
- LEDs: 1 Green, 1 Red
- Multi-frequency buzzer

PRODUCT COMPATIBILITY
- Compatible with all the mechanical locks equipped with an European profile cylinder hole (EN 1303, DIN 18252)

MOUNTING
- On door

ENVIRONMENTAL FEATURES
- IP66
- IP67
- IP68
- IP69

WORKING TEMPERATURE
-25°C / +65°C

STORAGE TEMPERATURE
-25°C / +65°C

PACKAGE
1 cylinder, 1 battery, cylinder fixing screw, 2 mm hex key, instruction sheet

ACCESSORIES (NOT INCLUDED)

- Pre-assembled modules
- Assembled components Modular Libra
- Electronic knob spare parts
- Premium knob cover (RFID and mechanical version)
- Standard mechanical knob
- Anti-theft accessories
- Tool set for assembly/disassembly
- Modular cylinder mounting fixture
- Design packs

ONLINE CONTENT

 Web page

 User manual

 Warnings

 Data sheet

 Installation guide

 Leaflet

 Specifications

Libra X Smart Half

MODULAR HALF KNOB CYLINDER WITH EXTERNAL ELECTRONIC RFID/BLUETOOTH® KNOB (FREE-ROTATING)

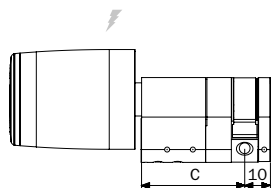

Technical features

FIRMWARE
ARGO

POWER UNIT
13V lithium battery type CR123

ESTIMATED BATTERY LIFE
Up to 2 years, up to 20.000 opening.
The figure is dependent on the mode and environment of use and the options activated.

ALERTS
- LEDs: 1 Green, 1 Red
- Multi-frequency buzzer

PRODUCT COMPATIBILITY
- Compatible with all the mechanical locks equipped with an European profile cylinder hole (EN 1303, DIN 18252)

MOUNTING
- On door

ENVIRONMENTAL FEATURES
- IP66
- IP67
- IP68
- IP69

WORKING TEMPERATURE
-25°C / +65°C

STORAGE TEMPERATURE
-25°C / +65°C

PACKAGE
1 cylinder, 1 battery, cylinder fixing screw, 2 mm hex key, instruction sheet

ACCESSORIES (NOT INCLUDED)
- Pre-assembled modules
- Assembled components Modular Libra
- Electronic knob spare parts
- Premium knob cover (RFID and mechanical version)
- Standard mechanical knob
- Anti-theft accessories
- Tool set for assembly/disassembly
- Modular cylinder mounting fixture
- Design packs

 Code configurator

 Accessories

DIMENSIONS

Electronic knob dimensions:
- External diameter from 36 to 39 mm
- Length: 49 mm

ONLINE CONTENT

 Web page

 User manual

 Warnings

 Data sheet

 Installation guide

 Leaflet

 Specifications

Libra X Smart Double

MODULAR CYLINDER WITH EXTERNAL ELECTRONIC RFID/BLUETOOTH® KNOB (FREE-ROTATING) AND INTERNAL ELECTRONIC KNOB (FREE-ROTATING)

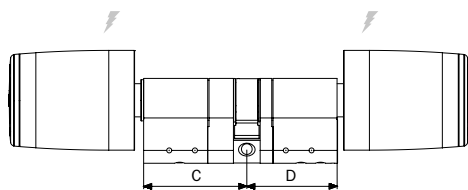

 Code configurator

 Accessories

DIMENSIONS

Electronic knob dimensions:

- External diameter from 36 to 39 mm
- Length: 49 mm

Technical features

FIRMWARE
ARGO

POWER UNIT
13V lithium battery type CR123

ESTIMATED BATTERY LIFE
Up to 2 years, up to 20.000 opening.
The figure is dependent on the mode and environment of use and the options activated.

ALERTS

- LEDs: 1 Green, 1 Red
- Multi-frequency buzzer

PRODUCT COMPATIBILITY

- Compatible with all the mechanical locks equipped with an European profile cylinder hole (EN 1303, DIN 18252)

MOUNTING

- On door

ENVIRONMENTAL FEATURES

- IP66
- IP67
- IP68
- IP69

WORKING TEMPERATURE
-25°C / +65°C

STORAGE TEMPERATURE
-25°C / +65°C

PACKAGE
1 cylinder, 2 battery, cylinder fixing screw, 2 mm hex key, instruction sheet

ACCESSORIES (NOT INCLUDED)

- Pre-assembled modules
- Assembled components Modular Libra
- Electronic knob spare parts
- Premium knob cover (RFID and mechanical version)
- Standard mechanical knob
- Anti-theft accessories
- Tool set for assembly/disassembly
- Modular cylinder mounting fixture
- Design packs

ONLINE CONTENT

 Web page

 User manual

 Warnings

 Data sheet

 Installation guide

 Leaflet

 Specifications

Libra X Smart Removable reader and Extension plug 16 mm

MODULAR CYLINDER FOR ARMORED DOORS WITH EXTERNAL ELECTRONIC RFID/BLUETOOTH® KNOB (FREE ROTATION), COMPATIBLE WITH CYLINDERS ESCUTCHEON, EXTENSION PLUG AND PRE-ARRANGED FOR INTERNAL KNOB SHAFT D 8X16 mm

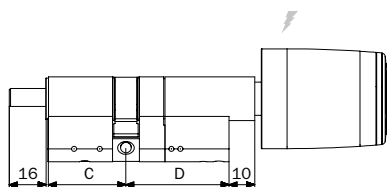

Technical features

FIRMWARE
ARGO

POWER UNIT
13V lithium battery type CR123

ESTIMATED BATTERY LIFE
Up to 2 years, up to 20.000 opening.
The figure is dependent on the mode and environment of use and the options activated.

ALERTS
- LEDs: 1 Green, 1 Red
- Multi-frequency buzzer

PRODUCT COMPATIBILITY
- Compatible with all the mechanical locks equipped with an European profile cylinder hole (EN 1303, DIN 18252)

MOUNTING
- On door

ENVIRONMENTAL FEATURES
- IP66
- IP67
- IP68
- IP69

WORKING TEMPERATURE
-25°C / +65°C

STORAGE TEMPERATURE
-25°C / +65°C

PACKAGE
1 cylinder, 1 battery, cylinder fixing screw, 2 mm hex key, instruction sheet

ACCESSORIES (NOT INCLUDED)
- Pre-assembled modules
- Assembled components Modular Libra
- Electronic knob spare parts
- Premium knob cover (RFID and mechanical version)
- Standard mechanical knob
- Anti-theft accessories
- Tool set for assembly/disassembly
- Modular cylinder mounting fixture
- Design packs

 Code configurator

 Accessories

DIMENSIONS

Electronic knob dimensions:
- External diameter from 36 to 39 mm
- Length: 49 mm

ONLINE CONTENT

 Web page

 User manual

 Warnings

 Data sheet

 Installation guide

 Leaflet

 Specifications

Libra X Smart Removable reader and Extension plug 75 mm

MODULAR CYLINDER FOR ARMORED DOORS WITH EXTERNAL ELECTRONIC RFID/BLUETOOTH® KNOB (FREE ROTATION), COMPATIBLE WITH CYLINDERS ESCUTCHEON, EXTENSION PLUG AND PRE-ARRANGED FOR INTERNAL KNOB SHAFT D 8X75 mm

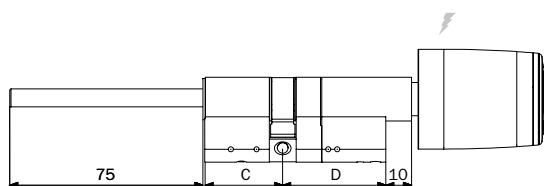

Technical features

FIRMWARE
ARGO

POWER UNIT
13V lithium battery type CR123

ESTIMATED BATTERY LIFE
Up to 2 years, up to 20.000 opening.
The figure is dependent on the mode and environment of use and the options activated.

ALERTS
- LEDs: 1 Green, 1 Red
- Multi-frequency buzzer

PRODUCT COMPATIBILITY
- Compatible with all the mechanical locks equipped with an European profile cylinder hole (EN 1303, DIN 18252)

MOUNTING
- On door

ENVIRONMENTAL FEATURES
- IP66
- IP67
- IP68
- IP69

WORKING TEMPERATURE
-25°C / +65°C

STORAGE TEMPERATURE
-25°C / +65°C

PACKAGE
1 cylinder, 1 battery, cylinder fixing screw, 2 mm hex key, instruction sheet

ACCESSORIES (NOT INCLUDED)
- Pre-assembled modules
- Assembled components Modular Libra
- Electronic knob spare parts
- Premium knob cover (RFID and mechanical version)
- Standard mechanical knob
- Anti-theft accessories
- Tool set for assembly/disassembly
- Modular cylinder mounting fixture
- Design packs

 Code configurator

 Accessories

DIMENSIONS

Electronic knob dimensions:
- External diameter from 36 to 39 mm
- Length: 49 mm

ONLINE CONTENT

 Web page

 User manual

 Warnings

 Data sheet

 Installation guide

 Leaflet

 Specifications

Libra X Smart Dummy-knob

MODULAR CYLINDER FOR ARMORED DOORS WITH EXTERNAL ELECTRONIC RFID/BLUETOOTH® KNOB (FREE ROTATION) AND KNOB-DUMMY ON INTERNAL SIDE

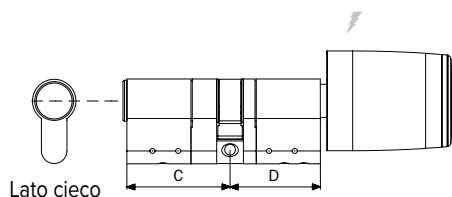

 Code configurator

 Accessories

DIMENSIONS

Electronic knob dimensions:

- External diameter from 36 to 39 mm
- Length: 49 mm

Technical features

FIRMWARE
ARGO

POWER UNIT
13V lithium battery type CR123

ESTIMATED BATTERY LIFE
Up to 2 years, up to 20.000 opening.
The figure is dependent on the mode and environment of use and the options activated.

ALERTS
- LEDs: 1 Green, 1 Red
- Multi-frequency buzzer

PRODUCT COMPATIBILITY
- Compatible with all the mechanical locks equipped with an European profile cylinder hole (EN 1303, DIN 18252)

MOUNTING
- On door

ENVIRONMENTAL FEATURES
- IP66
- IP67
- IP68
- IP69

WORKING TEMPERATURE
-25°C / +65°C

STORAGE TEMPERATURE
-25°C / +65°C

PACKAGE
1 cylinder, 1 battery, cylinder fixing screw, 2 mm hex key, instruction sheet

ACCESSORIES (NOT INCLUDED)
- Pre-assembled modules
- Assembled components Modular Libra
- Electronic knob spare parts
- Premium knob cover (RFID and mechanical version)
- Standard mechanical knob
- Anti-theft accessories
- Tool set for assembly/disassembly
- Modular cylinder mounting fixture
- Design packs

ONLINE CONTENT

 Web page

 User manual

 Warnings

 Data sheet

 Installation guide

 Leaflet

 Specifications

Libra X Smart Oval Australian

OVAL AUSTRALIAN ELECTRONIC CYLINDER WITH EXTERNAL RFID/BLUETOOTH® ELECTRONIC KNOB (FREE ROTATION)

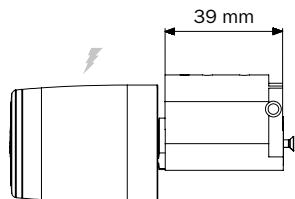

 Code configurator

 Accessories

DIMENSIONS

Electronic knob dimensions:

- External diameter from 36 to 39 mm
- Length: 49 mm

Technical features

FIRMWARE
ARGO

POWER UNIT
13V lithium battery type CR123

ESTIMATED BATTERY LIFE
Up to 2 years, up to 20.000 opening.
The figure is dependent on the mode and environment of use and the options activated.

ALERTS

- LEDs: 1 Green, 1 Red
- Multi-frequency buzzer

PRODUCT COMPATIBILITY

- Compatible with all the mechanical locks equipped with an Australian profile cylinder hole

MOUNTING

- On door

ENVIRONMENTAL FEATURES

- IP66
- IP67
- IP68
- IP69

WORKING TEMPERATURE
-25°C / +65°C

STORAGE TEMPERATURE
-25°C / +65°C

PACKAGE
1 cylinder, 1 battery, 2 mm hex key, instruction sheet

ACCESSORIES (NOT INCLUDED)

- Pre-assembled modules
- Assembled components Modular Libra
- Electronic knob spare parts
- Premium knob cover (RFID and mechanical version)
- Standard mechanical knob
- Anti-theft accessories
- Tool set for assembly/disassembly
- Modular cylinder mounting fixture
- Design packs

ONLINE CONTENT

 Web page

 User manual

 Warnings

 Data sheet

 Installation guide

 Leaflet

 Specifications

Libra X Smart Oval Scandinavian

OVAL SCANDINAVIAN ELECTRONIC CYLINDER WITH EXTERNAL ELECTRONIC RFID/BLUETOOTH® KNOB (FREE ROTATION)

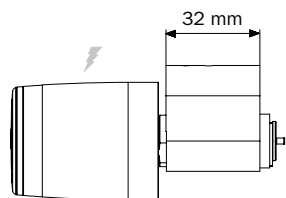

 Code configurator

 Accessories

DIMENSIONS

Electronic knob dimensions:

- External diameter from 36 to 39 mm
- Length: 49 mm

Technical features

FIRMWARE
ARGO

POWER UNIT
13V lithium battery type CR123

ESTIMATED BATTERY LIFE
Up to 2 years, up to 20.000 opening.
The figure is dependent on the mode and environment of use and the options activated.

ALERTS

- LEDs: 1 Green, 1 Red
- Multi-frequency buzzer

PRODUCT COMPATIBILITY

- Compatible with all the mechanical locks equipped with a Scandinavian profile cylinder hole

MOUNTING

- On door

ENVIRONMENTAL FEATURES

- IP66
- IP67
- IP68
- IP69

WORKING TEMPERATURE
-25°C / +65°C

STORAGE TEMPERATURE
-25°C / +65°C

PACKAGE
1 cylinder, 1 battery, cylinder fixing screws for internal door side versions, 2 mm hex key, instruction sheet

ACCESSORIES (NOT INCLUDED)

- Pre-assembled modules
- Assembled components Modular Libra
- Electronic knob spare parts
- Premium knob cover (RFID and mechanical version)
- Standard mechanical knob
- Anti-theft accessories
- Tool set for assembly/disassembly
- Modular cylinder mounting fixture
- Design packs

ONLINE CONTENT

 Web page

 User manual

 Warnings

 Data sheet

 Installation guide

 Leaflet

 Specifications

Libra X Smart

Accessories

PRE-ASSEMBLED MODULES (1/3)



EXTERNAL WITHOUT COVER.

Multistandard RFID reader (ISO14443A/ISO14443B 13,56 Mhz) on the outside.

IP protection degree IP66/IP67/IP68/IP69 for all versions. Available Heavy Duty version with drilling protection.

Packaging: 1 knob, 1 battery, fixing screw.

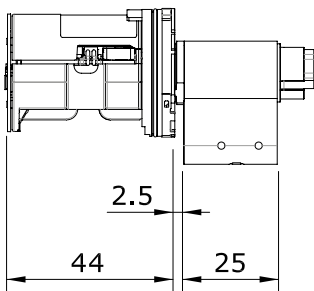

Electronic standard knob external side.

Nickel 1 8MX20K0009065

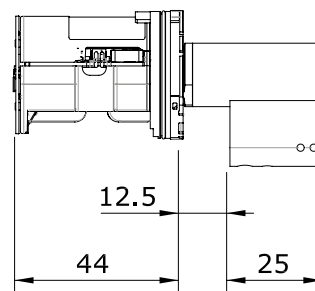

Electronic Heavy Duty knob external side removable

Nickel 1 8MX30K0009065

NOTE: to be coupled only with internal module for armoured door

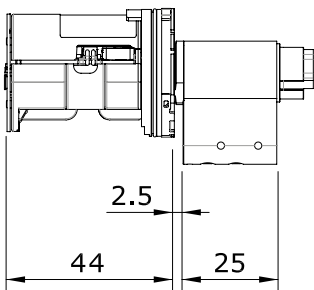

Electronic Heavy Duty knob outer side.

Nickel 1 8MX10K0009065

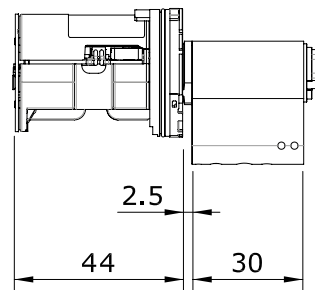

Electronic Heavy Duty knob external side removable.

Nickel 1 8MX40K0009065

NOTE: to be coupled only with internal module for armoured door

Libra X Smart

Accessories



PRE-ASSEMBLED MODULE (2/3)

INTERNAL WITHOUT COVER.

Multistandard RFID reader (ISO14443A/ISO14443B 13,56 Mhz) on the inside.

IP protection degree IP66/IP67/IP68/IP69 for all versions.

Packaging: 1 knob, 1 battery, fixing screw.

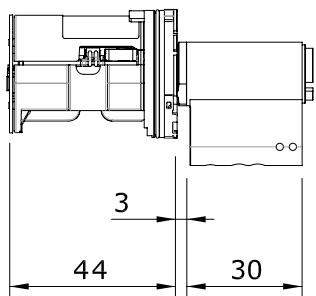

Electronic knob inside 35 mm.

Nickel 1 8MX20K1009065

Libra X Smart

Accessories

PRE-ASSEMBLED MODULE (3/3)

INTERNAL WITHOUT KNOB.
Packaging: 1 module.

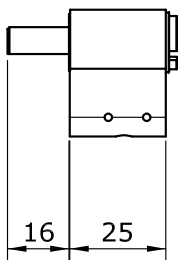

Shaft internal module 16 mm.
Nickel 1 8MX26K1009000

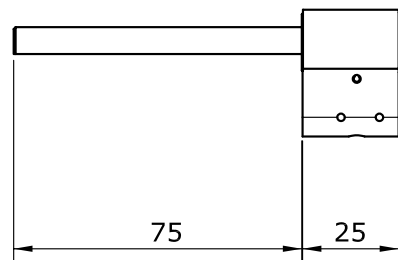

Shaft internal module 75 mm for armored door
Nickel 1 8MX3DK1009000

NOTE: to be coupled only with external module for armoured door

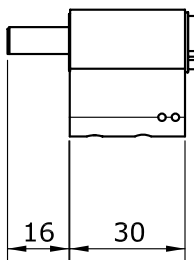

Shaft internal module 16 mm. For Panic.
Nickel 1 8MX26K1009000P

NOTE: to be coupled only with external module for armoured door

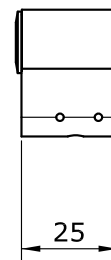

Module internal side for blind version: Libra LE60 Dummy Knob.
Nickel 1 8MX2CK1009000

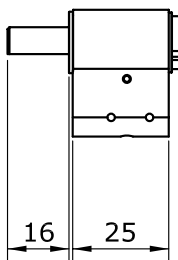

Shaft internal module 16 mm for armoured door.
Nickel 1 8MX36K1009000

NOTE: to be coupled only with external module for armoured door

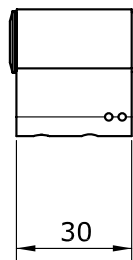

Module internal side for blind version: Libra LE60 Dummy Knob.
For Panic.
Nickel 1 8MX2CK1009000P

Libra X Smart

Accessories

MODULAR LIBRA X ASSEMBLED COMPONENTS

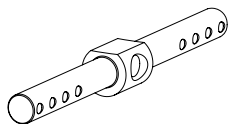

Kit 5 pcs. connecting bar for double cylinder.

3030 / 3035 / 3535	0033230
3040 / 3045 / 3540 / 3545	0033240
4040 / 4045 / 4545	0033250
3050 / 3055 / 3550 / 3555	0033260
3060 / 3065 / 3560 / 3565	0033270
4050 / 4055 / 4550 / 4555	0033280
5050 / 5055 / 5555	0033290
3070 / 3075 / 3570 / 3575	0033300
4060 / 4065 / 4560 / 4565	0033310
3080 / 3085 / 3580 / 3585	0033320
4070 / 4075 / 4570 / 4575	0033330
5060 / 5065 / 5560 / 5565	0033340
6060 / 6065 / 6565	0033350
3090 / 3095 / 3590 / 3595	0033360
4080 / 4085 / 4580 / 4585	0033370
5070 / 5075 / 5570 / 5575	0033380
4090 / 4095 / 4590 / 4595	0033390
5080 / 5085 / 5580 / 5585	0033400
6070 / 6075 / 6570 / 6575	0033410

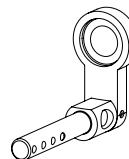

Kit 5 pcs. connecting bar for single cylinder.

3010 / 3510	0033450
4010 / 4510	0033460
5010 / 5510	0033470
6010 / 6510	0033480
7010 / 7510	0033490
8010 / 8510	0033500
9010 / 9510	0033510

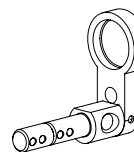

Kit 5 pcs. connecting bar for single cylinder.
removable external control

3510	0033936
4010	0033937
4510	0033938
5010	0033939
5510	0033940
6010	0033941
6510	0033942
7010	0033943
7510	0033944
8010	0033945
8510	0033946
9010	0033947

Libra X Smart

Accessories

MODULAR LIBRA X ASSEMBLED COMPONENTS

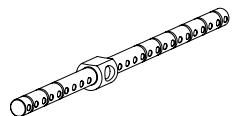

Universal connecting bar for standard version (8MX10*/8MX20* / 8MX18*/8MX28*/8MX1C*/8MX2C*)	
Kit 2 pcs. 30÷60/30÷90	0033520
Kit 2 pcs. 30÷80/30÷180	0033552
Kit 2 pcs. 30÷130/30÷130	0033553

Universal connecting bar for special version	
Kit 2 pcs. side with special function 35÷85 / 30÷90 standard side	0033935
Kit 2 pcs. side with special function 40÷90 / 30÷90 standard side	0033934

can only be cut every 10 mm

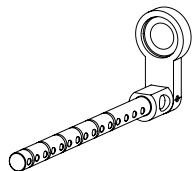

Universal connecting bar, single profile cylinder (image given for illustrative purposes only).	
Kit 2 pcs. 30÷90/10 stainless steel	0033530
Kit 2 pcs. 95÷180/10 stainless steel	0033551

Connecting bar 0033551 is drilled from 95 mm

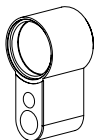

Extension for cylinder body.	
Kit 5 pcs. body extension 5 mm	0034211
Kit 5 pcs. body extension 10 mm	0034212
Kit 5 pcs. body extension 15 mm	0034213
Kit 5 pcs. body extension 20 mm	0034214
Kit 5 pcs. body extension 40 mm	0034215



Extension for cylinder body.	
Kit 5 pcs. body extension 5 mm	0033911
Kit 5 pcs. body extension 10 mm	0033912
Kit 5 pcs. body extension 15 mm	0033913
Kit 5 pcs. body extension 20 mm	0033914
Kit 5 pcs. body extension 40 mm	0033915
Kit 5 pcs. body extension 80 mm	0033916

Libra X Smart

Accessories

MODULAR LIBRA X ASSEMBLED COMPONENTS



Kit 100 pcs. steel fixing pins 0033740



Kit 100 pcs. connecting ring 0033917



Kit 100 pcs. 2 Set caps electronic modular cylinder Libra body 0033919



Kit 10 pcs. Cam plug for the cylinder Libra Modular mono 0033927



Kit 10 pcs. Cam. 0° for knob modular cylinder Libra stainless steel 0033918

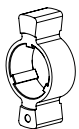

1 pcs Cam BIFFAR modular cylinder Libra stainless steel 1 0033933

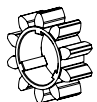

Cogwheel Z= 10 7,8 mm modular for cylinder Libra stainless steel 1 0033929

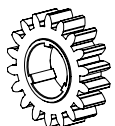

Cogwheel Z= 18 7,8 mm modular for cylinder Libra stainless steel 1 0033928

Libra X Smart

Accessories

ELECTRONIC KNOB SPARE PARTS

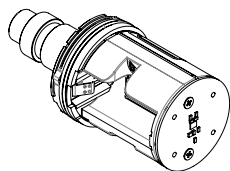

Libra X Rotors, without cover, without battery.

External rotor Libra X Standard	1	0034201
External rotor Libra X Heavy Duty	1	0034202
Internal rotor Libra X Double	1	0034203

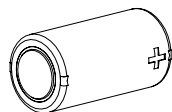

BATTERY (compatible only with Libra X)

Lithium battery FDK CR17335EF 3V 1400 mAh

Lithium battery FDK CR17335EF 3V 1400 mAh	1	0033960
---	---	---------

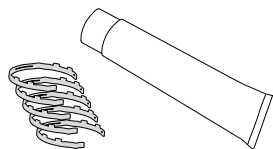

KIT WITH COVER RETAINING RING AND GREASE

Recommended spare kit for replacing the cover retaining ring and lubricating the rubber O-ring.

Package contents: 5 retaining rings, 1 tube of grease.

Kit with cover retaining ring and grease	1	0034216
--	---	---------

Libra X Smart

Accessories

“PREMIUM” KNOB COVER (RFID AND MECHANICAL VERSIONS)

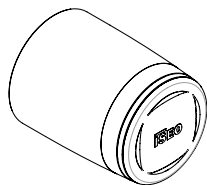

“PREMIUM” KNOB COVER

Suitable both for RFID reader knob and “Premium” mechanical knob.

Inox - Matte White	2	0444624
Inox - Matte Black	2	0444625
Kit 5 pz Inox - Matte White	1	0444724
Kit 5 pz Inox - Matte Black	1	0444725

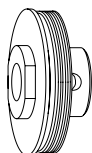

ADAPTER FOR MECHANICAL PREMIUM KNOB

It allows the usage of the Premium covers as mechanical inside knobs.

Package: 1 adaptor, 1 fixing screw.

	10	0444640
Kit 5 pcs	1	0444740

“STANDARD” MECHANICAL KNOB

“STANDARD” MECHANICAL KNOB

Internal mechanical knob.

Packaging: 1 knob, 1 battery, fixing screw.

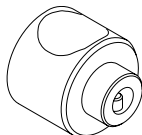

Inox	10	044232
Kit 5 pcs Inox	1	044322

Libra X Smart

Accessories

ANTI-INTRUSION ACCESSORIES

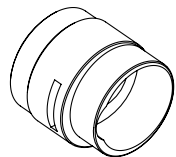

ANTI-INTRUSION PROTECTION KIT

For Libra cylinder, for armoured doors.

Satin inox	1	044252
------------	---	--------

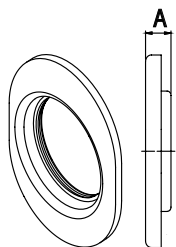

ANTI-INTRUSION ESCUTCHEON KIT

For Libra cylinder, for armoured doors.

A= 13 mm, satin inox	1	044262
----------------------	---	--------

A= 17 mm, satin inox	1	044272
----------------------	---	--------

Libra X Smart

Accessories

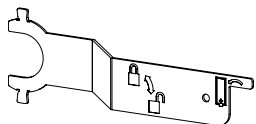

LIBRA X KNOB ASSEMBLY/DISASSEMBLY TOOL

ASSEMBLY/DISASSEMBLY TOOLING KIT FOR ELECTRONIC KNOB COVER

Necessary for battery replacement.

Package: 1 tool, instruction sheet

PLEASE NOTE: tool set not included with the Libra X. To order separately.

1 003140

ASSEMBLY TOOLING KIT FOR MODULAR CYLINDERS

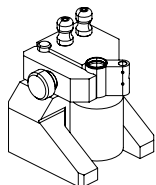

INSTALLATION TOOL FOR MODULAR CYLINDER LE60

Tool necessary for the assembly of modular cylinders.

Package: installation tool, 2 blocking pins

NOTE: the cylinders are supplied WITHOUT this tool. ORDER SEPARATELY.

1 0033097

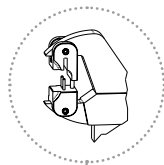

Pin driver tool on modular cylinder clamp

1 0033094

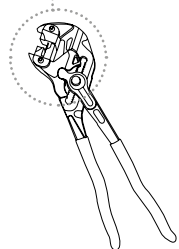

Libra X Smart

Accessories

PACKAGING DESIGN



Kit Libra X modular

1

0034207

Package: 1 cylinder 8MX2830302565 with 1 battery
 fixing screw, 2 mm hex key, instruction sheet + Cover disassembling tool
 1 master card set 5E405309.3

Smart Relay 2.0



Make your access points smart

The Smart Relay allows to open electric locks, motorized gate or any electrical actuator which can be activated closing a contact.

Concealed installation

The Smart Relay device can have an integrated or external Bluetooth® antenna, in order to install the device even in unconventional installation spaces: the antenna can be installed in another point and connected to the device.

Product's functions

- REX (REquest to eXit) is an Opto-insulated input to open the relay with a button distant up to 100 meters.
- The OUTPUT relay is a signal relay (1A) and can be also configured as NO (default) or NC by a jumper under the cover enclosure. It can be configured with the ARGO App for different functions.
- Memorize up to 300 users credentials
- Records the last 1000 events
- Wake up by RFID card detection or phone Bluetooth® (patented)
- Block the Standard Users allowing access only to VIP users
- Programming and software updates by ARGO App on iOS and Android devices

Go to page

MODELS

- Built in Bluetooth® p. 76
- External Bluetooth® (max 3 meters) p. 77

ENVIRONMENTAL CHARACTERISTICS

- Max. 95% without condensing

CREDENTIALS

- Smartphone
- Apple Watch

COMMUNICATION INTERFACE

- Bluetooth® Low Energy 5.1

Smart Relay 2.0

Selection guide

Smart Relay controls electric locks, motorised gates or any electrical actuator that can be activated by closing a contact. The Smart Relay closes the relay contact when an authorized smartphone, previously registered on the device, sends an open command through the ARGO App. Smart Relay is available in two versions, which adapt to different installation requirements.

ORDER THE PRODUCT IN A FEW STEPS

1

Choose the appropriate template for your application and click in the column on the right :

Smart Relay with integrated Bluetooth® antenna

Device used for installations where there are no range problems of the Bluetooth® signal (approx. 10 m between smartphone and Smart Relay).

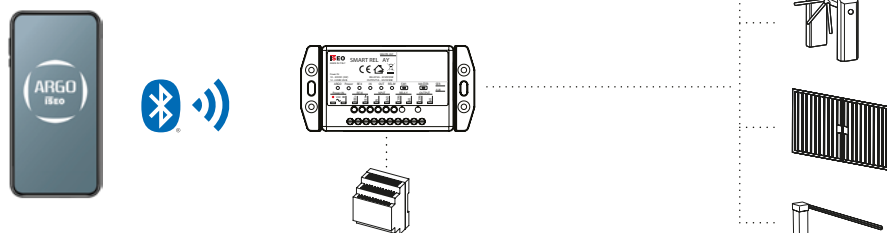

Smart Relay with external Bluetooth® antenna

To be used in case it is necessary to remote the Bluetooth® antenna from the installation of the Smart Relay. The length of the cable supplied for the external antenna is 3 m.

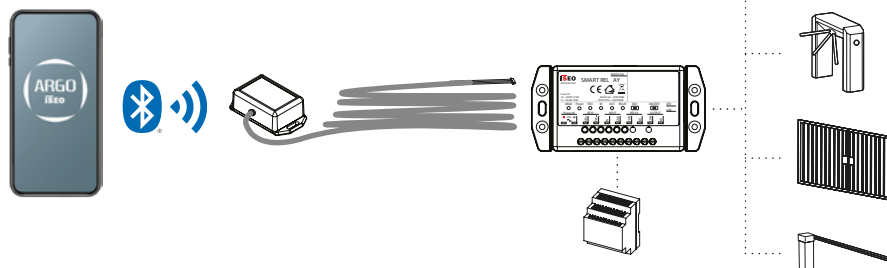

Go to page

SELECTION GUIDE

MODELS

- Built in Bluetooth® p. 76
- External Bluetooth® (max 3 meters) p. 77

Smart **Relay** 2.0 Built in Built in Bluetooth®

CONNECTED ACTUATOR WITH BUILT IN BLUETOOTH®

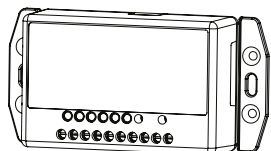

Technical features

FIRMWARE
ARGO

RELEASE
2.0

POWER UNIT
10÷30 Vdc (2W)
12÷24 Vac (4VA)

MOUNTING
- Wall mounted
- Flush mounted
- DIN Rail 35 mounted

ENVIRONMENTAL FEATURES
- H.R. max. 95% without condensing

WORKING TEMPERATURE
-25°C ÷ +70°C

STORAGE TEMPERATURE
-25°C ÷ +70°C

PACKAGE
1 Smart Relay, 1 Plastic pin to setup Programming Mode,
1 DIN rail mounting clip
with screws, 1 Installation guide (EN/IT)

code **5E065501**

DIMENSIONS

- Width: 109 mm
- Height: 53 mm
- Thickness: 26 mm

ONLINE CONTENT

 [Web page](#)

 [Data sheet](#)

 [Leaflet](#)

 [User manual](#)

 [Installation guide](#)

 [Specifications](#)

 [Door entry system solution with Smart Relay and IS9100 automatic door operator](#)

 [Door entry system solution with Smart Relay and electric gate](#)

 [Door entry system solution with Smart Relay and Multiblindo Emotion.](#)

Smart Relay 2.0 External Bluetooth® (max 3 meters)

CONNECTED ACTUATOR WITH EXTERNAL BLUETOOTH®

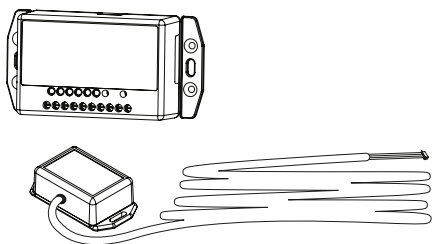

Technical features

FIRMWARE
 ARGO

RELEASE
 2.0

POWER UNIT
 10÷30 Vdc (2W)
 12÷24 Vac (4VA)

MOUNTING
 - Wall mounted
 - Flush mounted
 - DIN Rail 35 mounted

ENVIRONMENTAL FEATURES
 - H.R. max. 95% without condensing

WORKING TEMPERATURE
 -25°C ÷ +70°C

STORAGE TEMPERATURE
 -25°C ÷ +70°C

PACKAGE
 1 Smart Relay, 1 Plastic pin to setup Programming Mode, 1 DIN rail mounting clip with screws, 1 Bluetooth® remote module with 3 meters cable, 1 Installation guide (EN/IT)

code **5E065502**

DIMENSIONS

Smart Relay's dimensions:
 - Width: 109 mm
 - Height: 53 mm
 - Depth: 26 mm

Bluetooth® Antenna's dimensions:
 - Width: 65 mm
 - Height: 35 mm
 - Depth: 15 mm

ONLINE CONTENT

- Web page
- Data sheet
- Leaflet

- User manual
- Installation guide
- Specifications

- Door entry system solution with Smart Relay and IS9100 automatic door operator
- Door entry system solution with Smart Relay and electric gate
- Door entry system solution with Smart Relay and Multiblindo Emotion.

Multiblindo Smart



Choose the configuration that best suits your needs

The ISEO self-closing motorized lock is the perfect combination of comfort of use and safety in all situations. Multiblindo Smart has the possibility of choosing between different configurations, completely battery powered or mains powered, with or without backup battery, to be used in the event of an electrical blackout.

Open as you like

The installation of Multiblindo Smart locks is recommended to protect entrances of homes, offices, commercial spaces and bed & breakfasts. In combination with the new ones INCA Readers and using your smartphone, manage access to your spaces intuitively and secure, monitoring activities in real time and simplifying permission management. The sensors on board the lock guarantee constant monitoring of access and of the door status, visible on smartphones and tablets.

MATERIAL

Stainless steel

Product features

- Closing the leaf, the lock engages the deadbolts automatically
- Memorize up to 300 users credentials
- Records the last 1000 events
- Wake up by RFID card detection or phone (patented)
- Low energy consumption device
- Real Time Clock/Calendar
- Permanently open mode (office mode) without extra battery consumption
- Door Status option with cable with Relay Output to manage an automatic door operator or to be used for home automation systems
- Detection of opening by key, mechanical handle and external input (button)
- Door status and lock status monitoring
- Block the Standard Users allowing access only to VIP users
- Programming and software updates by ARGO App on iOS and Android devices

Go to page

CONFIGURATIONS

- Full battery p. 80
- Powered by 24Vdc with backup batteries p. 81
- Powered by 24Vdc p. 82

MODELS

- Multiblindo Smart p. 83

ACCESS CREDENTIALS

- Apple Watch
- Badge
- Bracelet
- Numeric Keypad
- Fingerprint
- Keyfob
- Smartphone

COMMUNICATION INTERFACE

- Check the communication interfaces of lock's compatible readers

CERTIFICATIONS

- EN 14846:2008 with the classification |3|X|9|E|0|P|7|1|3|
- EN 179: 2008 with the classification |3|7|7|B|1|4|5|2|3|
- EN 1125 certification available in combination with specific panic devices and locks

Multiblindo Smart

Selection guide

Multiblindo Smart features a modular design to suit various installation needs. This catalog allows you to select the desired configuration for the lock, define the necessary components, and check the connections.

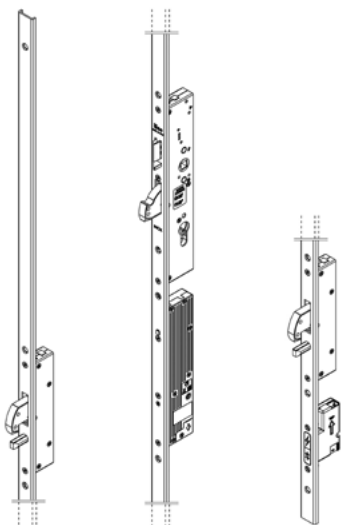

ORDER THE PRODUCT IN A FEW STEPS

1

Check **the type of application and the available installation spaces**, particularly assessing whether it is possible to run a power cable to the door.

3

Optional.
Refer to the accessory sheets for component modifications and replacements.

Choose from menu

[Connection box](#)

[Connection cables](#)

[Batteries](#)

[Power supply unit](#)

2

Choose **the desired configuration and lock model in the right column**, generating the code using the configurator on the product page.

4

Choose **the suitable 1NCA Smart reader model** for your application.

Note: Verify the compatibility of the reader with the desired Multiblindo Smart configuration.

Choose the 1NCA Smart reader

Go to page

SELECTION GUIDE

CONFIGURATIONS

- Full battery p. 80
- Powered by 24Vdc with backup batteries p. 81
- Powered by 24Vdc p. 82

MODELS

- Multiblindo Smart p. 83

Multiblindo Smart



Full battery

No wiring is required. The lock **operates only using alkaline batteries**.

There are two battery packs on the door (9 Alkaline AA batteries in total).

In this configuration, **1NCA Smart Readers Cable Free** can be used if needed. If no reader is paired, the lock can still be managed with the **ARGO smartphone app**.

It is not possible to install an output relay in this configuration to monitor the door status or manage a swing door operator.

Reader type



1NCA Smart Cable Free

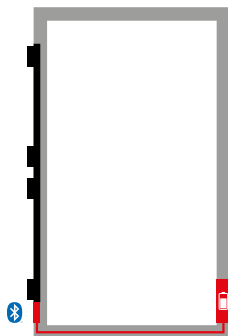

Installation guide
for the configuration



No Reader

The lock can be managed
using the ARGO App
from a smartphone.

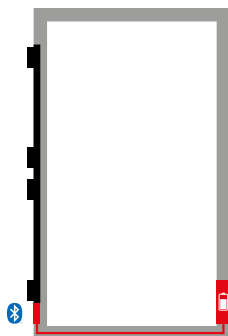

Installation guide
for the configuration



You can choose the **1NCA Smart** reader model suitable for your application in the dedicated section of the catalog.

Note: Verify the compatibility of the reader with the desired Multiblindo Smart configuration.

Go to page

SELECTION GUIDE

CONFIGURATIONS

- Full battery p. 80
- Powered by 24Vdc with backup batteries p. 81
- Powered by 24Vdc p. 82

MODELS

- Multiblindo Smart p. 83

Multiblindo Smart



Powered by 24Vdc with backup batteries

The power supply is provided by an **external 24Vdc power** adapter connected to the electrical network, and there is a **backup battery pack (9 Alkaline AA)** on the door to keep the lock operational in case of power outage (blackout).

In this configuration, **1NCA Smart Cable Free** and **1NCA Smart Standard** can be used if required (you can choose the desired model in this catalog).

If no reader is paired, the lock can still be managed with the **ARGO App from a smartphone**.

Additionally, you can add an **output relay** to monitor the door status or manage an automatic door operator.

Reader type

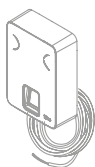

1NCA Smart Standard

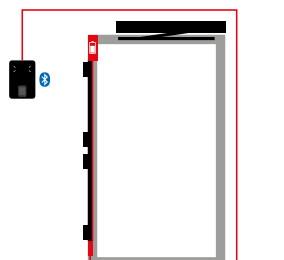

Installation guide for the configuration with output relay

[BKW+R]

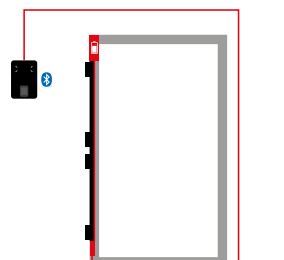

Installation guide for the configuration without output relay

[BKW]



1NCA Smart Cable Free

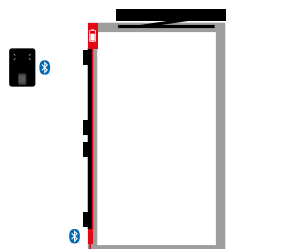

Installation guide for the configuration with output relay

[BKF+R]

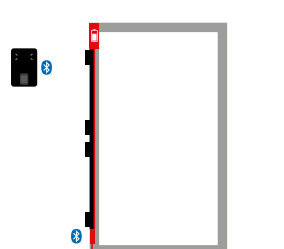

Installation guide for the configuration without output relay

[BKF]

No Reader

The lock can be managed using the **ARGO App** from a smartphone.

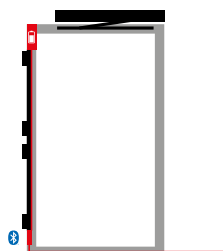

Installation guide for the configuration with output relay

[BKF+R]

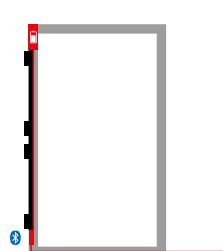

Installation guide for the configuration without output relay

[BKF]

You can choose the **1NCA Smart reader model** suitable for your application in the dedicated section of the catalog.

Note: Verify the compatibility of the reader with the desired Multiblindo Smart configuration.

Go to page

SELECTION GUIDE

CONFIGURATIONS

- Full battery p. 80
- Powered by 24Vdc with backup batteries p. 81
- Powered by 24Vdc p. 82

MODELS

- Multiblindo Smart p. 83

Multiblindo Smart



The power supply is provided by an external 24V power adapter connected to the electrical network. In this configuration, **1NCA Smart Cable Free**, **1NCA Smart Standard** or **1NCA Smart Mullion 485** can be used if required (you can choose the desired model in this catalog). If no reader is paired, the lock can still be managed with the **ARGO App** from a smartphone. Additionally, you can add an **output relay** to monitor the door status or manage an automatic door operator.

Reader type

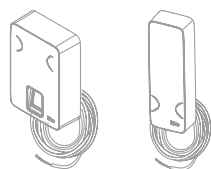

1NCA Smart Standard
1NCA Smart Mullion 485

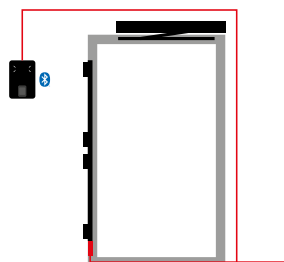

Installation guide for the configuration with output relay
[\[PWW+R\]](#)

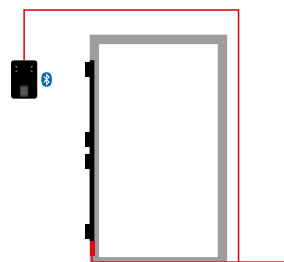

Installation guide for the configuration without output relay
[\[PWW\]](#)



1NCA Smart Cable Free

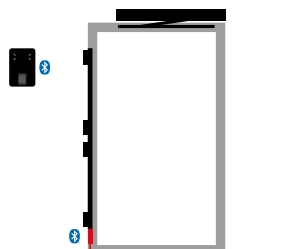

Installation guide for the configuration with output relay
[\[PWF+R\]](#)

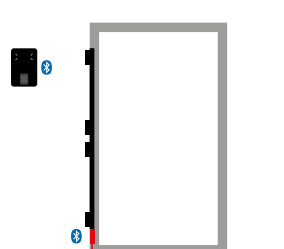

Installation guide for the configuration without output relay
[\[PWF\]](#)

No Reader

The lock can be managed using the **ARGO App** from a smartphone.

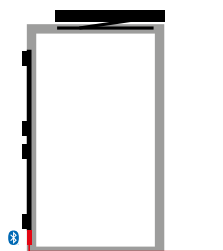

Installation guide for the configuration with output relay
[\[PWF +R\]](#)

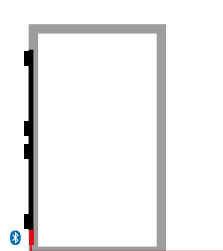

Installation guide for the configuration without output relay
[\[PWF\]](#)

You can choose the **1NCA Smart reader model** suitable for your application in the dedicated section of the catalog.

Note: Verify the compatibility of the reader with the desired Multiblindo Smart configuration.

Go to page

SELECTION GUIDE

CONFIGURATIONS

- Full battery p. 80
- Powered by 24Vdc with backup batteries p. 81
- Powered by 24Vdc p. 82

MODELS

- Multiblindo Smart p. 83

Multiblindo Smart

MOTORIZED SELF-LOCKING MULTI-POINT LOCK, WITH A HIGH LEVEL OF SECURITY, SUITABLE FOR METAL FRAME DOORS MULTIPLE LOCKING POINTS, TO BE COMBINED WITH CONNECTION BOX

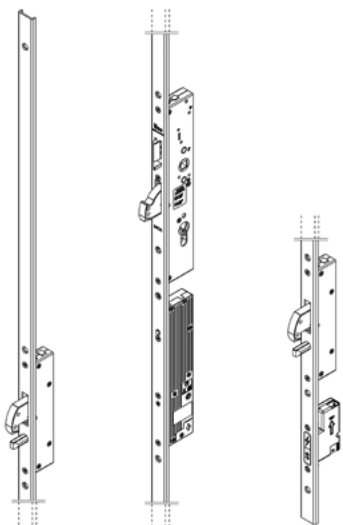

Technical features

FIRMWARE

ARGO

POWER UNIT

Configurable power:

- 24Vdc mains power supply
- 24Vdc mains power supply and backup battery on the door (which guarantees the use of the access even if the main power supply is interrupted)
- Battery powered (no cable needed for main power)

ESTIMATED BATTERY LIFE

Up to 2 years, up to 10.000 opening. The figure is dependent on the mode and environment of use and the options activated.

HARDWARE SPECIFICATIONS

- Electromechanical 24vdc multipoint mortice lock for metal frames, self-locking latchbolt and 3 deadbolts, rotating hook deviators and pin. Deadbolts and latchbolt operated by key, handle or motor. Lock and deviators deadbolts with anti-drill and anti-cut cover plates in hardened steel. Adapter for 8 mm square handle, 2 nylon end blocks for U-version

ALERTS

- Multi-frequency buzzer

PRODUCT COMPATIBILITY

- The addition of the 1NCA Smart Cable Free or 1NCA Smart Standard readers allows entry with different electronic credentials, configuration, validity and times. Up to 300 credentials in total can be combined with the lock

- For metal frame doors with multiple locking points
- European profile cylinder

MOUNTING

- On door

ENVIRONMENTAL FEATURES

- H.R. max. 95% without condensing

WORKING TEMPERATURE

-20°C ÷ +70°C

STORAGE TEMPERATURE

-20°C ÷ +70°C

PACKAGE

1 Multipoint lock L 2300 mm, Door status magnet, lock fixing screws, installation manual.

ACCESSORIES (NOT INCLUDED)

- Connection Box (see operating and power configurations)
- Motor/Connection Box cable (see operating configurations)
- Flexible cable for rim and mortice mounting
- Battery pack
- Batteries
- Counterplates
- Magnet holder
- Emergency handle or panic bar
- Emergency mechanical cylinder
- Extensions

 Code configurator

 Accessories

DIMENSIONS

Lock length 2300 mm, center distance 92 mm

Lock and deviators deadbolts 27 mm throw

Connection cable length 6 m (not included)

ONLINE CONTENT

 Web page

 User manual

 Data sheet

 Installation guide

 Leaflet

 Specifications

Multiblindo Smart

Accessories

CONNECTION BOX

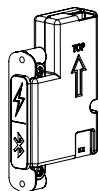
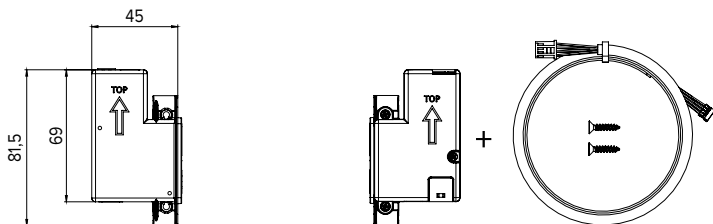

CONNECTION BOX FOR EXTERNAL 24VDC POWER SUPPLY, WITH BLUETOOTH®

Used in Multiblindo Smart configurations Powered by 24Vdc with Cable Free reader (PWF) and Powered by 24Vdc with Cable Free reader and output relay (PWF+R).

Package: 1 Connection Box, 1 cable, instruction manual.

1

7A0E110

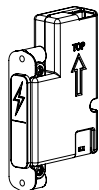

CONNECTION BOX FOR EXTERNAL WIRED POWER SUPPLY, WITHOUT BLUETOOTH®

Used in Multiblindo Smart configurations Powered by 24Vdc with wired reader (PWW) and Powered by 24Vdc with wired reader and output relay (PWW+R).

Package: 1 Connection Box, 1 cable, instruction manual.

1

7A0E120

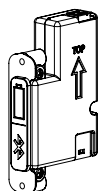

CONNECTION BOX FOR CONFIGURATION WITH BACKUP BATTERIES, WITH BLUETOOTH®

Used in Multiblindo Smart configurations Powered by 24Vdc with backup batteries and Cable Free reader (BKF), Powered by 24Vdc with backup batteries, Cable Free reader and Relay (BKF+R) and Full Battery (FB), version without external 24Vdc power supply.

Package: 1 Connection Box, 1 cable, instruction manual.

1

7A0E130

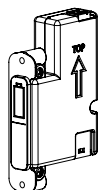

CONNECTION BOX FOR CONFIGURATION WITH BACKUP BATTERIES, WITHOUT BLUETOOTH®

Used in Multiblindo Smart configurations Powered by 24Vdc with backup batteries and wired reader (BKW) and Powered by 24Vdc with backup batteries, wired reader and output relay (BKW+R).

Package: 1 Connection Box, 1 cable, instruction manual.

1

7A0E140

Multiblindo Smart

Accessories

CONNECTION CABLES AND BATTERIES

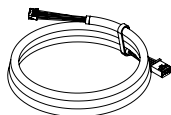

6-WIRE CONNECTION CABLE FOR MULTIBLINDO SMART

Used in Multiblindo Smart configurations Powered by 24Vdc with wired reader (PWW) and Powered by 24Vdc with backup batteries with wired reader (BKW).

Package: 1 Connection Cable 1 7A0E200

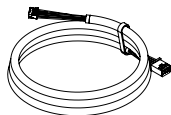

4-WIRE CONNECTION CABLE FOR MULTIBLINDO SMART

Used in Multiblindo Smart configurations Powered by 24Vdc with Cable Free reader (PWF) and Powered by 24Vdc with backup batteries with Cable Free reader (BKF).

Package: 1 Connection Cable 1 7A0E210

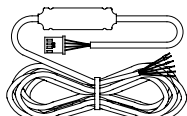

6-WIRE CONNECTION CABLE FOR MULTIBLINDO SMART

Used in Multiblindo Smart configurations Powered by 24Vdc with Cable Free reader and output relay (PWF+R) and Powered by 24Vdc with backup batteries, Cable Free reader and output relay (BKF+R)

Package: 1 Connection Cable 1 7A0E220

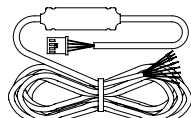

8-WIRE CONNECTION CABLE FOR MULTIBLINDO SMART

Used in Multiblindo Smart configurations Powered by 24Vdc with wired reader and output relay (PWF+R) and Powered by 24Vdc with backup batteries, wired reader and output relay (BKF+R)

Package: 1 Connection Cable 1 7A0E230

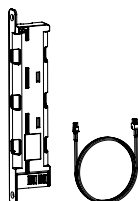

SINGLE BATTERY HOLDER + CONNECTION CABLE

Single battery holder in black nylon for 9 type AA batteries. Compatible with Multiblindo Smart, supplied with connection cable. (batteries not provided).

Package: 1 Battery holder, 1 connection cable 1 7A0E300

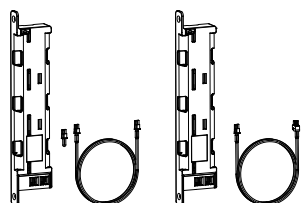

DOUBLE BATTERY HOLDER + CONNECTION CABLES

Double battery holder in black nylon for 9x2 type AA batteries. Compatible with Multiblindo Smart, supplied with connection cables. (batteries not provided).

Package: 2 Battery holder, 2 connection cables 1 7A0E310

PACKAGE 9 BATTERIES

Duracell Procell AA alkaline battery 1 7A0E320

Multiblindo Smart

Accessories

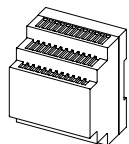

POWER SUPPLY UNIT 24VDC - 70W

Input 120-230Vac. Output 24Vdc 3A.
DIN35 rail mounting.

Package: 1 Power Supply, instruction manual

1

5E3502



FLEXIBLE CABLE FOR RIM MOUNTING, EXTERNAL

Length 300 mm, for opening up to 180°

1

94403010E

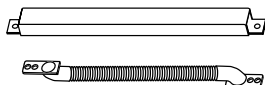

FLEXIBLE CABLE FOR RIM MOUNTING, EXTERNAL

Length 290 mm, for opening up to 90°

1

94403110E

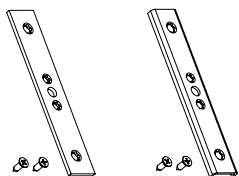

STAINLESS STEEL PLATE FOR MAGNET HOLDER

with flat front plate - dimensions 24X3 mm

1

033103

with U-shaped front plate - dimensions 24X6 mm

1

033104

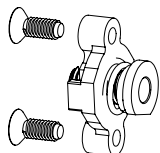

DOOR ALIGNMENT SENSOR – SPARE PART

Door status contact sensor to be installed in the strike plate of Multiblindo Smart.

Spare part, as it is already included in the lock package.

Supplied complete with support bracket and fixing screws.

1

0000IS00366

X1R Smart 2.0



Control for security doors

X1R Smart is a motorised electronic lock specifically designed for security doors. It combines the solidity of a mechanical lock with the versatility of electronic control via smartphone, RFID tag or keypad.

Choose your preferred credential

The security doors equipped with X1R Smart lock offer to the user the possibility of accessing with the ARGO App from a Smartphone and with RFID devices. It is also possible to have a numeric keypad and fingerprint reader on the door, to allow access to the user without having to use any physical credentials.

Product's functions

- Opening via PIN code and finger print.
- Motorised opening and closing of deadbolts and latchbolt.
- Quick opening from inside the room with "Single Action" handle (optional).
- Opening via European profile cylinder (EN 1303, DIN 18252).
- Light function (latch only) programmable by the user for certain days and time slots.
- Memorize up to 300 users credentials
- Records the last 1000 events
- Battery-operated device with charge status detection
- Wake up by RFID card detection or phone Bluetooth® (patented)
- Low energy consumption device
- Real Time Clock/Calendar
- Light and acoustic signals
- Permanently open mode (office mode) without no extra battery consumption
- Block the Standard Users allowing access only to VIP users
- Programming and software updates by ARGO App on iOS and Android devices

ENVIRONMENTAL CHARACTERISTICS

- IP44

CREDENTIALS

- Apple Watch
- Badge
- Bracelet
- Numeric Keypad
- Fingerprint
- Keyfob
- Smartphone

COMMUNICATION INTERFACE

- Check the communication interfaces of X1R-compatible readers

CERTIFICATIONS

- EN 14846:2008 with the classification I3|X|9|E|0|P|7|1|13|

Go to page

MODELS

- Rim version p. 89
- Rim version Single Action with quick release via the handle p. 90
- Mortice version p. 91
- Mortice version Single Action with quick release via the handle p. 92
- Panic 4RM Motorized and anti-panic lock for armoured doors - Rim version p. 93

X1R Smart 2.0

Selection guide

X1R Smart is a motorised electronic lock specially designed for application on armoured doors.

It combines the robustness of a mechanical lock with the versatility of electronic control via Smartphone, RFID tag or keypad.

ORDER THE PRODUCT IN A FEW STEPS

1

Check the type and dimensions of the X1R Smart lock.

3

Choose the **control module** and **accessories best** suited to your needs.

Choose from menu

Control modules

Other accessories

2

Choose the model of the X1R Smart in the column on the right.

4

Optional.
Choose accessories to complete the system.

Go to page

SELECTION GUIDE

MODELS

- Rim version p. 89
- Rim version Single Action with quick release via the handle p. 90
- Mortice version p. 91
- Mortice version Single Action with quick release via the handle p. 92
- Panic 4RM Motorized and anti-panic lock for armoured doors - Rim version p. 93

X1R Smart 2.0 Rim version

MOTORIZED ELECTRONIC LOCK SPECIFICALLY DESIGNED FOR SECURITY DOORS, RIM VERSION

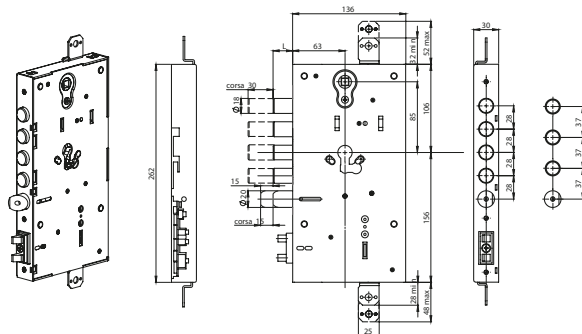

Click on the product code to download the right datasheet

4 DEADBOLTS. Projection 3. Centre distance 28	0006960328550
4 DEADBOLTS. Projection 13. Centre distance 28	0006961328550
3 DEADBOLTS. Projection 3. Centre distance 37	0006960337550
3 DEADBOLTS. Projection 13. Centre distance 37	0006961337550

 Accessories

DIMENSIONS

Deadbolts in chrome-plated steel \varnothing 18 mm, projection 30 mm
Reversible latchbolt \varnothing 20 mm, adjustable projection
Handle follower 8 mm for latchbolt operation

Technical features

FIRMWARE
ARGO

RELEASE
2.0



POWER UNIT
Battery operated with 6 1.5 VDC alkaline batteries
Power supply from 8 to 30 VDC 30W
Consumption at rest 0.05A – Maximum (forced) 2.5A



ESTIMATED BATTERY LIFE
Up to 3 years, up to 30.000 opening.
The figure is dependent on the mode and environment of use and the options activated.

PRODUCT COMPATIBILITY

- Top and bottom attachments for rods for additional closures
- Set up for M6 passing screws for cylinder protection fixing
- Reversible door sensor with adjustable projection, including alignment device
- Rim fixing with 4 passing screws or screw nuts
- Inox version on request

ONLINE CONTENT

 [Web page](#)
 [Data sheet](#)
 [Leaflet](#)

 [User manual](#)
 [Installation guide](#)
 [Specifications](#)

MOUNTING
- On armored door

ENVIRONMENTAL FEATURES
- IP44

WORKING TEMPERATURE
-20°C ÷ +70°C

STORAGE TEMPERATURE
-25°C ÷ +75°C

PACKAGE
Lock, door sensor, cylinder fixing screws, assembly instructions

ACCESSORIES (NOT INCLUDED)

- Smart Readers for X1R
- Power supply
- Concealed lead cover

 Door entry system solution with X1R Smart lock and IS9100 automatic door operator.

X1R Smart 2.0 Rim version Single Action with quick release via the handle

MOTORIZED ELECTRONIC LOCK SPECIFICALLY DESIGNED FOR SECURITY DOORS, RIM VERSION SINGLE ACTION

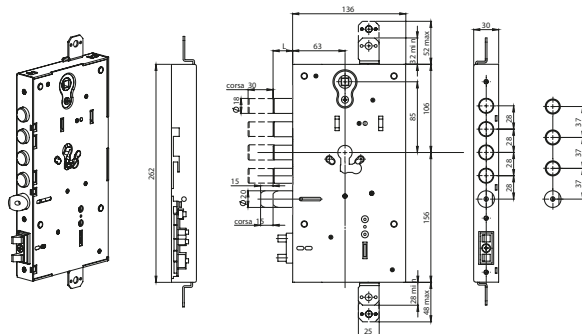

Click on the product code to download the right datasheet

4 DEADBOLTS. Projection 3. Centre distance 28.	0006990328550
4 DEADBOLTS. Projection 13. Centre distance 28	0006991328550
3 DEADBOLTS. Projection 3. Centre distance 37	0006990337550
3 DEADBOLTS. Projection 13. Centre distance 37	0006991337550

 Accessories

DIMENSIONS

Deadbolts in chrome-plated steel \varnothing 18 mm, projection 30 mm
Reversible latchbolt \varnothing 20 mm, adjustable projection
Handle follower 8 mm for latchbolt operation

Technical features

FIRMWARE
ARGO

RELEASE
2.0



POWER UNIT
Battery operated with 6 1.5 VDC alkaline batteries
Power supply from 8 to 30 VDC 30W
Consumption at rest 0.05A – Maximum (forced) 2.5A



ESTIMATED BATTERY LIFE
Up to 3 years, up to 30.000 opening.
The figure is dependent on the mode and environment of use and the options activated.

PRODUCT COMPATIBILITY

- Top and bottom attachments for rods for additional closures
- Set up for M6 passing screws for cylinder protection fixing
- Reversible door sensor with adjustable projection, including alignment device
- Rim fixing with 4 passing screws or screw nuts
- Inox version on request

ONLINE CONTENT

 [Web page](#)
 [Data sheet](#)
 [Leaflet](#)

 [User manual](#)
 [Installation guide](#)
 [Specifications](#)

MOUNTING
- On armored door

ENVIRONMENTAL FEATURES
- IP44

WORKING TEMPERATURE
-20°C ÷ +70°C

STORAGE TEMPERATURE
-25°C ÷ +75°C

PACKAGE
Lock, door sensor, cylinder fixing screws, assembly instructions

ACCESSORIES (NOT INCLUDED)

- Smart Readers for X1R
- Power supply
- Concealed lead cover

 Door entry system solution with X1R Smart lock and IS9100 automatic door operator.

X1R Smart 2.0 Mortice version

MOTORIZED ELECTRONIC LOCK SPECIFICALLY DESIGNED FOR SECURITY DOORS, MORTICE VERSION

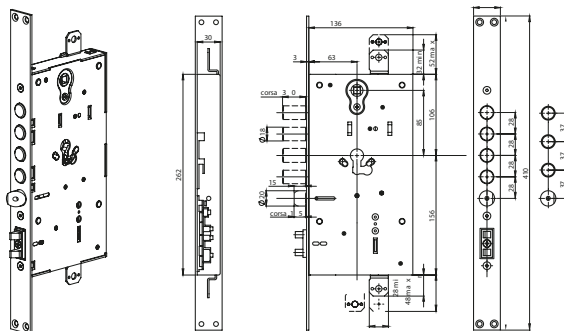

Click on the product code to download the right datasheet

4 DEADBOLTS. Centre distance 28 [0006960028550](#)

3 DEADBOLTS. Centre distance 37 [0006960037550](#)

 Accessories

DIMENSIONS

Deadbolts in chrome-plated steel \varnothing 18 mm, projection 30 mm
 Reversible latch \varnothing 20 mm, adjustable projection
 Handle follower 8 mm for latchbolt operation

Technical features

FIRMWARE
ARGO

RELEASE
2.0

POWER UNIT
 Battery operated with 6 1.5 VDC alkaline batteries
 Power supply from 8 to 30 VDC 30W
 Consumption at rest 0.05A – Maximum (forced) 2.5A

ESTIMATED BATTERY LIFE
 Up to 3 years, up to 30.000 opening.
 The figure is dependent on the mode and environment of use and the options activated.

PRODUCT COMPATIBILITY

- Top and bottom attachments for rods for additional closures
- Set up for M6 passing screws for cylinder protection fixing
- Reversible door sensor with adjustable projection, including alignment device
- Mortice fixing with front plate in chrome-plated steel 410x35x3 mm
- Inox version on request

MOUNTING
- On armored door

ENVIRONMENTAL FEATURES
- IP44

WORKING TEMPERATURE
-20°C ÷ +70°C

STORAGE TEMPERATURE
-25°C ÷ +75°C

PACKAGE
Lock, door sensor, cylinder fixing screws, assembly instructions.

ACCESSORIES (NOT INCLUDED)

- Smart Readers for X1R
- Power supply
- Concealed lead cover

ONLINE CONTENT

 Web page

 Data sheet

 Leaflet

 User manual

 Installation guide

 Specifications

 Door entry system solution with X1R Smart lock and IS9100 automatic door operator.

X1R Smart 2.0 Mortice version Single Action with quick release via the handle

MOTORIZED ELECTRONIC LOCK SPECIFICALLY DESIGNED FOR SECURITY DOORS, MORTICE VERSION SINGLE ACTION

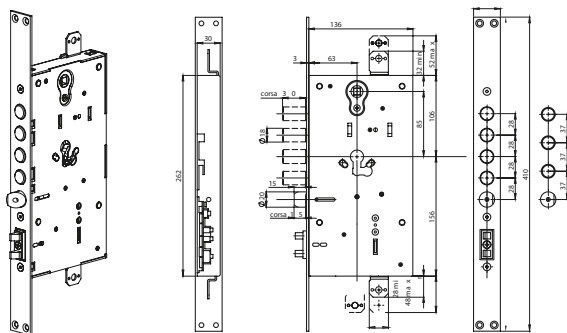

Click on the product code to download the right datasheet

4 DEADBOLTS. Centre distance 28 **0006990028550**

3 DEADBOLTS. Centre distance 37 **0006990037550**

 Accessories

DIMENSIONS

Deadbolts in chrome-plated steel \varnothing 18 mm, projection 30 mm
 Reversible latch \varnothing 20 mm, adjustable projection
 Handle follower 8 mm for latchbolt operation

Technical features

FIRMWARE
ARGO

RELEASE
2.0

POWER UNIT
 Battery operated with 6 1.5 VDC alkaline batteries
 Power supply from 8 to 30 VDC 30W
 Consumption at rest 0.05A – Maximum (forced) 2.5A

ESTIMATED BATTERY LIFE
 Up to 3 years, up to 30.000 opening.
 The figure is dependent on the mode and environment of use and the options activated.

PRODUCT COMPATIBILITY

- Top and bottom attachments for rods for additional closures
- Set up for M6 passing screws for cylinder protection fixing
- Reversible door sensor with adjustable projection, including alignment device
- Mortice fixing with front plate in chrome-plated steel 410x35x3 mm
- Inox version on request

MOUNTING
- On armored door

ENVIRONMENTAL FEATURES
- IP44

WORKING TEMPERATURE
-20°C ÷ +70°C

STORAGE TEMPERATURE
-25°C ÷ +75°C

PACKAGE
Lock, door sensor, cylinder fixing screws, assembly instructions.

ACCESSORIES (NOT INCLUDED)

- Smart Readers for X1R
- Power supply
- Concealed lead cover

ONLINE CONTENT

 Web page

 Data sheet

 Leaflet

 User manual

 Installation guide

 Specifications

 Door entry system solution with X1R Smart lock and IS9100 automatic door operator.

X1R Smart 2.0 Panic 4RM Motorized and anti-panic lock for armoured doors - Rim version

MOTORISED ELECTRONIC LOCK SPECIFICALLY DESIGNED FOR SECURITY DOORS WITH ANTI-PANIC OR EMERGENCY FUNCTION, RIM VERSION

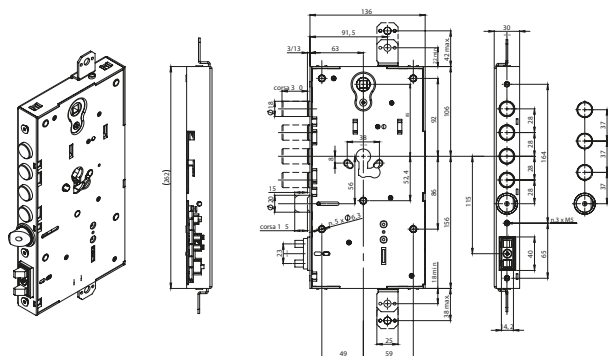

Click on the product code to download the right datasheet

4 DEADBOLTS, protrusion 3, centre distances 28 **00069H0328550**

4 DEADBOLTS, protrusion 13, centre distances 28 **00069H1328550**

3 DEADBOLTS, protrusion 3, centre distances 37 **00069H0337550**

3 DEADBOLTS, protrusion 13, centre distances 37 **00069H1337550**

 Accessories

DIMENSIONS

Deadbolt in chromed steel \varnothing 18 mm, stroke 30 mm
Reversible latch \varnothing 20 mm, adjustable protrusion
Square spindle 8 mm

Technical features

FIRMWARE
ARGO

RELEASE
2.0

POWER UNIT
Battery operated with 6 1.5 VDC alkaline batteries
Power supply from 8 to 30 VDC 30W
Consumption at rest 0.05A – Maximum (forced) 2.5A

ESTIMATED BATTERY LIFE
Up to 3 years, up to 30.000 opening.
The figure is dependent on the mode and environment of use and the options activated.

PRODUCT COMPATIBILITY

- Top and bottom attachments for rods for additional closures
- Set up for M6 passing screws for cylinder protection fixing
- Reversible door sensor with adjustable projection, including alignment device
- Suitable for fire-resistant doors

ONLINE CONTENT

 Web page

 Data sheet

 Leaflet

 User manual

 Installation guide

 Specifications

MOUNTING
- On armoured door

ENVIRONMENTAL FEATURES
- IP44

WORKING TEMPERATURE
-20°C ÷ +70°C

STORAGE TEMPERATURE
-25°C ÷ +75°C

PACKAGE
Lock, leaf approach contact, strike plate, cylinder fixing screws, instructions

ACCESSORIES (NOT INCLUDED)

- Smart Readers for X1R
- Power supply
- Concealed lead cover

X1R Smart 2.0

Accessories

CONTROL MODULES (1/3)



MULTI-READER

Compatible with X1R Smart.

Includes black cover and 3 connection cables L 1 mt.

Numeric keyboard, RFID reader 13,56 Mhz, Bluetooth®

“Wake on Hand” technology. Encrypted data communication protocol.

1 0000098108696



MULTI-READER WITH FINGERPRINT

Compatible with X1R Smart.

Includes black cover and 3 connection cables L 1 mt.

Numeric keyboard, RFID reader 13,56 Mhz, biometric reader, Bluetooth®

“Wake on Hand” technology. Encrypted data communication protocol.

1 0000098109696



EXTERNAL CONTROL MODULE WITH RFID READER 13.56 Mhz e Bluetooth®.

Compatible with X1R Smart, includes pair of connection cables L 100 cm.

Encrypted data communication protocol.

1 0000098105696



EXTERNAL CONTROL MODULE WITH KEYBOARD,

RFID READER 13,56 Mhz e Bluetooth®.

compatible with X1R Smart includes pair of connection cables L 100 cm

Encrypted data communication protocol.

1 0000098111696

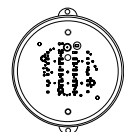

HIDDEN RFID READER and Bluetooth®. Compatible with X1R Smart.

Includes pair of connection cables L 100 cm

1 0000098106696

X1R Smart 2.0

Accessories

CONTROL MODULES (2/3)

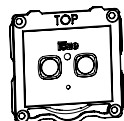

SQUARE INTERNAL CONTROL MODULE WITH 2 BUTTONS
 Compatible with X1R Smart, includes connection cable L 60 cm.
 Encrypted data communication protocol.

1 0000098PI2696

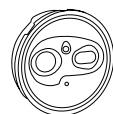

2-BUTTON INTERNAL CONTROL MODULE
 Compatible with X1R Smart, includes connection cable L 60 cm.
 Encrypted data communication protocol.

1 0000098PI0696

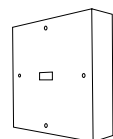

METAL BOX FOR HIDDEN READER
 Measure: 104 x 32 x 104 mm (L x W x H)

1 0000098NBM696

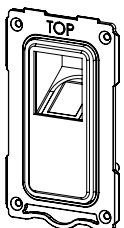

EMBEDDED FLUSH FINGERPRINT READER
 Compatible with X1R Smart. Includes pair of connection cables L 100 cm
 Encrypted data communication protocol.
 Required thickness inside the door 26 mm.

1 5E62100

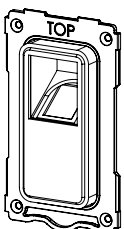

EMBEDDED PROTRUDING FINGERPRINT READER
 Compatible with X1R Smart. Includes pair of connection cables L 100 cm
 Encrypted data communication protocol.
 Required thickness inside the door 19 mm.

1 5E63100

X1R Smart 2.0

Accessories

CONTROL MODULES (3/3)

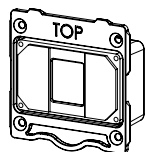

SURFACE MOUNTED FINGERPRINT READER
 Compatible with X1R Smart. Includes pair of connection cables L 100 cm
 Encrypted data communication protocol.
 Required thickness inside the door 15 mm.

1 5E62200

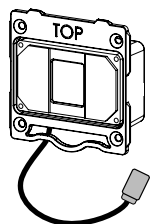

IP66 SURFACE MOUNTED FINGERPRINT READER
 Compatible with X1R Smart with embedded cable and IP66 connector.
 Encrypted data communication protocol.
 Required thickness inside the door 15 mm.

1 5E62220

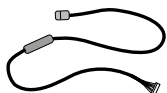

IP66 CABLE FOR FINGERPRINT READER L 1.2 mt.
 Connection cable between IP66 surface mounted fingerprint reader and X1R Smart

1 0000IS00246

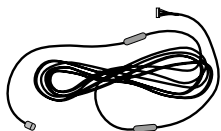

IP66 CABLE FOR FINGERPRINT READER L 10 mt.
 Connection cable between IP66 surface mounted fingerprint reader and X1R Smart

1 0000IS00247

X1R Smart 2.0

Accessories

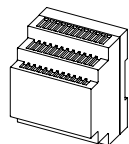

POWER SUPPLY UNIT 24Vdc - 30W
Input 120-230Vac. Output 24Vdc 1.2A.
DIN35 rail mounting.

Package: 1 power supply unit, instruction manual.

1 5E3506

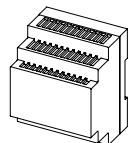

POWER SUPPLY UNIT 12Vdc - 70W
Input 120-230Vac. Output 12Vdc 3A.
DIN35 rail mounting.

Package: 1 power supply unit, instruction manual.

1 5E3509

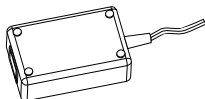

POWER SUPPLY UNIT 9V DC - 4 A for direct power.
Compatible with X1R Smart. Connection cable to X1R Smart NOT INCLUDED,
to be ordered separately by code 0000098MP0696
(8-POLE MULTIFUNCTION CONNECTION CABLE)

1 5E3507



CONCEALED LEAD COVER, flexible, external, L=300.
For openings up to 180°.

1 94403010E

CONCEALER LEAD COVER external, flush version L=300

1 94403110E

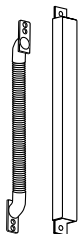

CONCELEAD LEAD COVER, flexible, flush version L=260.
For openings up to 90°.
Compatible con Thesis, Top Exit DGT, X1R.

1 00000881000000

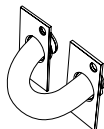

SPRING CONCELEAD LEAD COVER, flexible L=68.
For openings up to 180°.

1 0000060130000

X1R Smart 2.0

Accessories

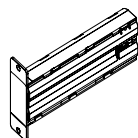

BATTERY HOLDER in black nylon for 6 D-type batteries
Compatible with X1R Smart supplied with bipolar connection
cable L 240 cm. (batteries not provided).

black	1	5820069600005
grey	1	5820069600015
white	1	5820069600025



6 D-TYPE BATTERIES 1.5V

ALKALINE	1	5820060000006
----------	---	---------------



BIPOLAR CONNECTION CABLE FOR REMOTE CONTROL
L 450 cm compatible with X1R Smart.

1	000098CR0696
---	--------------

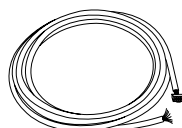

8-POLE MULTIFUNCTION CONNECTION CABLE L 450 CM FOR REMOTE CONTROL,
DOOR STATUS, DIRECT POWER AND LOCKBUS COMMUNICATION
Compatible with X1R Smart.

1	000098MP0696
---	--------------

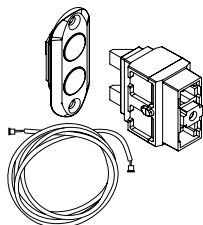

ADJUSTABLE DOOR CONTACT KIT FOR REMOTE CONTROL
Includes bipolar connection cable L 200 cm and door contact.
Compatible with X1R Smart.

1	000098MO2170
---	--------------

X1R Smart 2.0

Accessories

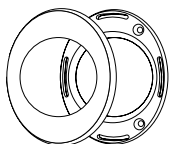

Universal single escutcheons made of a nylon base, brass cover and fixing screw.

Compatible with: *98PI0698, *98TE0698 e *98PE0698.

bronze plated	1	000098N0XBRO
polished chrome	1	000098N0XCRL
satın chrome	1	000098N0XCRS
polished brass varnished	1	000098N0XOLV
bronze plated	10	000098N1DBRO
polished chrome	10	000098N1DCRL
satın chrome	10	000098N1DCRS
polished brass varnished	10	000098N1DOLV

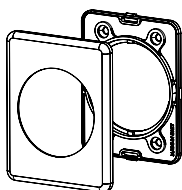

Universal rectangular single escutcheons made of a nylon base, brass cover and fixing screw.

Compatible with: all readers and round inserts code *98PI0698, *98TE0698 e *98PE0698.

bronze plated	1	000098N2XBRO
polished chrome	1	000098N2XCRL
satın chrome	1	000098N2XCRS
polished brass varnished	1	000098N2XOLV
bronze plated	10	000098N2DBRO
polished chrome	10	000098N2DCRL
satın chrome	10	000098N2DCRS
polished brass varnished	10	000098N2DOLV

X1R Smart 2.0

Accessories

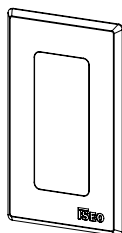

Cover for EMBEDDED FLUSH FINGERPRINT READER

Compatible with: 5E62100

polished black	1	5E621105
satin chrome	1	5E62110Y
polished brass	1	5E62110L

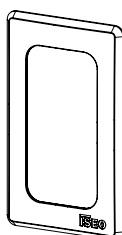

Cover for EMBEDDED PROTRUDING FINGERPRINT READER

Compatible with: 5E63100

polished black	1	5E631105
satin chrome	1	5E63110Y
polished brass	1	5E63110L

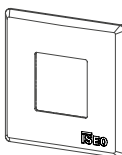

Cover for SURFACE MOUNTED FINGERPRINT READER

Compatible with: 5E62200

polished black	1	5E622105
satin chrome	1	5E62210Y
polished brass	1	5E62210L

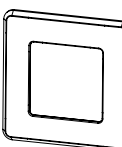

Square cover for 2-button internal control module.

Only compatible square 2-button internal control module code 000008PI2696

polished black	1	0000098CPI005
satin chrome	1	0000098CPI00Y
polished brass	1	0000098CPI00L
bronze	1	0000098CPI00B

Door Controller Smart

Go to page



Complete control of an electrified access point

The Door Controller Smart enables access control for a single electrified lock through a dedicated relay for the door lock, making it suitable for a wide range of applications.

Easy to install, ready to use

The Door Controller Smart is designed for quick and easy installation. For proper operation, it is sufficient to connect it to a 1NCA Standard or 1NCA Mullion 485 reader via a wired RS485 connection. Configuration is fast and intuitive: no specific programming is required, as the controller automatically recognises the connected reader.

Product's functions

- Allows the opening of electric doors, motorised gates, or any electrical actuator that can be activated by closing a contact.
- Door status sensor detects whether the door is open or closed, providing precise and constant door status monitoring.
- REX (REquest to eXit) is an opto-isolated input that allows relay activation via an exit button located up to 100 m away.
- Real Time Clock / Calendar.
- Manages one 1NCA Reader for access control.

MATERIAL

Technopolymer

COLOUR

White

COMMUNICATION INTERFACE

- RS485

CERTIFICATIONS

- Compliance with European and UK EMC directives
- EN IEC 61000-6-3: Electromagnetic Compatibility (EMC)
- EN IEC 61000-6-1: Electromagnetic Compatibility (EMC)
- EN IEC 62368-1: Audio/video, information and communication technology

MODELS

→ Door Controller Smart

p. 102

Door Controller Smart

ACCESS CONTROL UNIT FOR A SINGLE ELECTRIFIED LOCK VIA A DEDICATED RELAY, WITH DOOR STATUS MONITORING, CONNECTABLE TO 1 READER VIA RS485 CABLE.

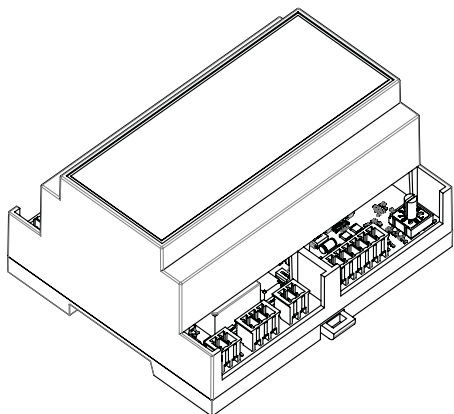

Technical features

FIRMWARE
ARGO

POWER SUPPLY
12÷24 Vac (max. 15W)

HARDWARE FEATURES

- INPUTS:
- REX Open Command (Request to Exit): internal opening command
- Door Contact: door sensor indicating whether the door is open or closed
- AUX Input Contact (RFU*)
- Tamper (RFU*)

- OUTPUTS:
- Door Lock RELAY (COM NO NC): supports both fail-safe and fail-secure locking devices
- Booster: enables the operation of an electric lock with solenoid; activated in parallel with the Door Lock
- RELAY
- AUX RELAY (RFU*)

*RFU = Reserved for Future Use

PRODUCT COMPATIBILITY

- For proper operation, the Smart Door Controller must always be equipped with either a 1NCA Smart Standard reader or a 1NCA Smart Mullion 485 reader
- The device supports 1 reader

MOUNTING

- DIN35 rail mounting

OPERATING TEMPERATURE

-20°C ÷ +60°C

STORAGE TEMPERATURE

-20°C ÷ +70°C

PACKAGE CONTENTS

- 1 Smart Door Controller
- 1 Connector Kit
- 1 Installation Guide

code **5E2515**

DIMENSIONS

- Height: 90 mm
- Depth: 58 mm
- Width: 106 mm (6 DIN modules)

ONLINE CONTENT

 [Web page](#)

 [Data sheet](#)

 [Leaflet](#)

 [User manual](#)

 [Installation guide](#)

 [Specifications](#)

Smart Gateway



Control the system remotely

With Smart Gateway, the ARGO system by ISEO can be controlled remotely, in residential but also in 'light' commercial environments, such as shops, small offices, B&Bs, where the new smart devices generation for door locks it can simplify your daily life and make logistics easier.

Connection security

The ARGO 3.0 system guarantees a secure connection thanks to Bluetooth® Low Energy 5.1 and end-to-end encryption, which manages communication without an intermediate server.

COLOR

White

COMMUNICATION INTERFACE

- Conversion from WIFI data to Bluetooth®
- Dual Band WIFI at 2.4 GHz and 5 GHz
- USB type C

Product's functions

- "Desktop" format with the possibility of wall mounting
- Data conversion (WIFI or Ethernet) to Bluetooth® Low Energy 5.1

Go to page

MODELS

- WIFI p. 105
- Power over Ethernet p. 106

Smart Gateway

Selection guide

Smart Gateway connects the cloud platform (ARGO account of ISEO) to the door lock. The device communicates with the cloud via the data connection and to the door lock via Bluetooth® Low Energy 5.1.

Smart Gateway can manage all door locks within the Bluetooth® operating radius (approx. 10 metres, depending on environmental conditions).

The Smart Gateway is available in two versions to adapt to different installation requirements.

ORDER THE PRODUCT IN A FEW STEPS

1

Choose the appropriate template for your application and click in the column on the right :

WiFi Smart Gateway

Device used for installations where it is preferred to use the WiFi network to connect the system to the Internet (residential market).

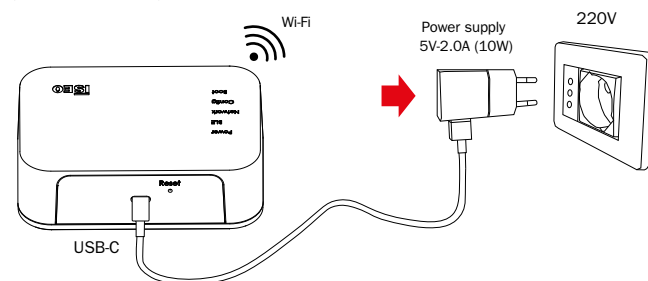

PoE Smart Gateway

To be used if the WiFi network is not present or has usage restrictions (tertiary/commercial market). The Ethernet connection can also be used as a power supply for the device (Power over Ethernet).

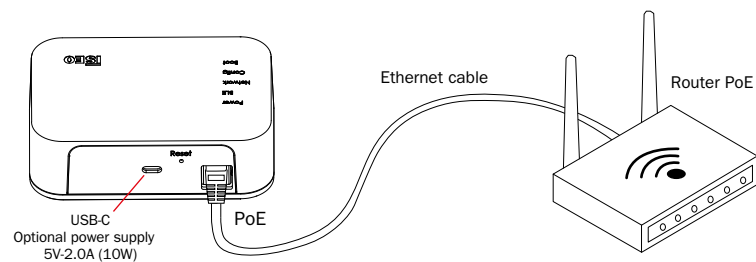

2

Optional.

Choose accessories to complete the system

Go to page

● SELECTION GUIDE

MODELS

→ WIFI p. 105

→ Power over Ethernet p. 106

Smart Gateway WIFI

IT ALLOWS YOU TO MANAGE YOUR ARGO SYSTEM FROM REMOTE WITHOUT CABLED IP CONNECTIONS

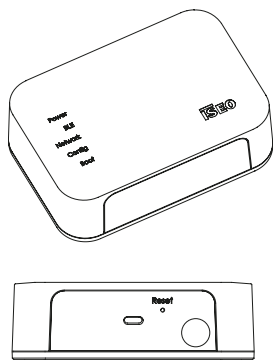

Technical features

FIRMWARE
ARGO

POWER UNIT
Powered by USB C +5VDC input power 2A (10W).
Power supply not included (accessory to order separately).

HARDWARE SPECIFICATIONS

- ARM A7 based CPU module
- 512 MB RAM
- 8 GB Flash eMMC Non volatile Memory

MOUNTING

- Desktop
- Wall mounted

WORKING TEMPERATURE
0°C ÷ +50°C

STORAGE TEMPERATURE
-25°C ÷ +75°C

PACKAGE
1 Smart Gateway WIFI
Power supply not included (accessory to order)

ACCESSORIES (NOT INCLUDED)

- Power supply (cod. 0000A00155)
- Wall fixing brackets kit (cod. 0000A00154)

code 5E075524

 Accessories

DIMENSIONS

- Width: 125 mm
- Depth: 40 mm
- Height: 85 mm

ONLINE CONTENT

- | | |
|--|--|
|  Web page |  User manual |
|  Data sheet |  Installation guide |
|  Leaflet |  Specifications |

Smart Gateway Power over Ethernet

CONNECT THE ARGO SYSTEM TO THE INTERNET VIA AN ETHERNET CABLE

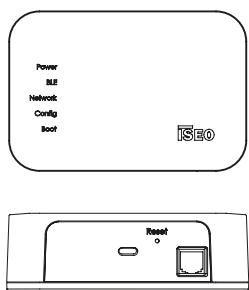

Technical features

FIRMWARE
ARGO

POWER UNIT
Requires PoE Switch IEEE 802.3af up to 15,4W.
Delivery of data and power over CAT5e/CAT6 ethernet cable.
Maximum power consumption 10W.

HARDWARE SPECIFICATIONS

- ARM A7 based CPU module
- 512 MB RAM
- 8 GB Flash eMMC Non volatile Memory

MOUNTING

- Desktop
- Wall mounted

WORKING TEMPERATURE
0°C ÷ +50°C

STORAGE TEMPERATURE
-25°C ÷ +75°C

PACKAGE
1 Smart Gateway PoE

ACCESSORIES (NOT INCLUDED)
- Wall fixing brackets kit (cod. 0000A00154)

code 5E075514

 Accessories

DIMENSIONS

- Width: 125 mm
- Depth: 40 mm
- Height: 85 mm

ONLINE CONTENT

- | | |
|--|--|
|  Web page |  User manual |
|  Data sheet |  Installation guide |
|  Leaflet |  Specifications |

Smart Gateway

Accessories

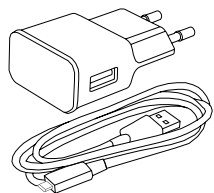

POWER SUPPLY
 IN = 100-240V50-60Hz 0.50A
 OUT = 5.0Vdc 2A (10W)
 USB A to USB C 1.5 mt cable

1 0000A00155

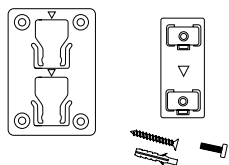

WALL FIXING KIT
 nr. 1 Wall bracket
 nr. 1 Gateway bracket
 nr. 2 Screws
 nr. 4 Wall plugs and screws

1 0000A00154

ARGO Cards

MASTER CARD SET.

3 cards (#1, #2, #3 the next Master automatically cancels the previous one).

Package: 3 cards, instructions.

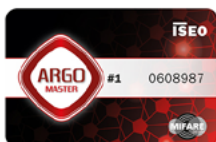

DESFire EV2

With ISEO logo

1

5E405309.3

USER CARDS



DESFire EV2

With ISEO logo and UID

1

5E405301



MIFARE CLASSIC

With ISEO logo and UID

10

5E402001.A

Blank on both sides

10

5E402011

ARGO Keyfob and bracelet

USER KEYFOB



Leather-like Keyfob DESFire EV2
With ISEO logo and UID

1 5E425301



Black ABS Keyfob DESFire EV2
With ISEO logo and UID

2 5E415101



MIFARE CLASSIC
With ISEO logo and UID

4 KEYFOB1356MF1



Silicone Wristband DESFire EV3
With ISEO logo and UID - Not suitable to be used with X1R Smart
Hidden RFID Reader

2 5E435101

Code configurator

Some products are available in different versions to suit customer requirements and the characteristics of the doors on which they are to be installed.

Please use the configurator of the specific product model to create the code you wish to order.

Aries Smart 2.1

[Go to page](#)

- Standard p. 111
- For panic devices p. 112
- For custom handles p. 113
- For custom handles, for panic devices p. 114
- For DIN lock p. 115
- For fire locks p. 116
- For Premi Apri Meroni locks p. 117

Libra X Smart

[Go to page](#)

- Standard p. 118
- Premium p. 119
- Half p. 120
- Double p. 121
- Removable reader and Extension plug 16 mm p. 122
- Removable reader and Extension plug 75 mm p. 123
- Dummy-knob p. 124
- Oval Australian p. 125
- Oval Scandinavian p. 126

Multiblindo Smart

[Go to page](#)

- Standard p. 127

Aries Smart 2.1 For panic devices

ELECTRONIC TRIM RFID/BLUETOOTH® SET FOR PANIC DEVICES

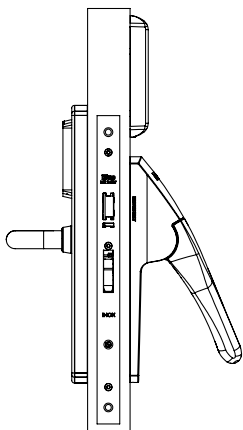

CODE CONFIGURATOR

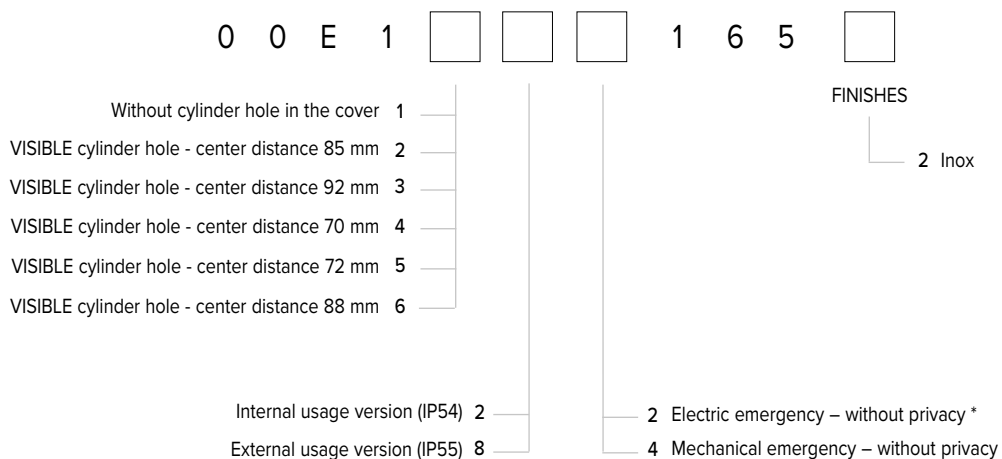

* ONLY compatible to configuration Without cylinder hole in the cover (code 1 in fifth position)

Product options

OVERRIDE CYLINDER HOLE EXTERNAL SIDE

To chose if a mechanical emergency cylinder is used. The mechanical cylinder is still accessible without cylinder hole, by turning the plate.

IP RATING

For internal (IP54) or external (IP55 with resistance to salty atmosphere) usage.

EMERGENCY OVERRIDE CYLINDER

High Security ISEO R90 Factory Monoprofile. Up to 3 mechanical recordings. Usage detected by electronics. KA on the same installation.

EXTERNAL EMERGENCY POWER SUPPLY

For installations with no override cylinder. Connector under external cover plate. Standard 9V battery usage.

Aries Smart 2.1 For custom handles

ELECTRONIC TRIM RFID/BLUETOOTH® SET FOR CUSTOM HANDLES

CODE CONFIGURATOR

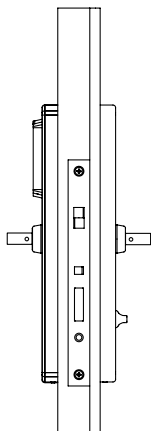

0 0 E 2 1 6 5 I

- Without cylinder hole in the cover 1
 - VISIBLE cylinder hole - center distance 85 mm 2
 - VISIBLE cylinder hole - center distance 92 mm 3
 - VISIBLE cylinder hole - center distance 70 mm 4
 - VISIBLE cylinder hole - center distance 72 mm 5
 - VISIBLE cylinder hole - center distance 88 mm 6
-
- Internal usage version (IP54) 1
 - External usage version (IP55) 7
-
- FINISHES
- 1 Industrial Packaging
 - 2 Inox
-
- 1 Electric emergency – with privacy *
 - 2 Electric emergency – without privacy *
 - 3 Mechanical emergency – with privacy
 - 4 Mechanical emergency – without privacy

* ONLY compatible to configuration Without cylinder hole in the cover (code 1 in fifth position)

Product options

OVERRIDE CYLINDER HOLE EXTERNAL SIDE

To choose if a mechanical emergency cylinder is used. The mechanical cylinder is still accessible without cylinder hole, by turning the plate.

IP RATING

For internal (IP54) or external (IP55 with resistance to salty atmosphere) usage.

EMERGENCY OVERRIDE CYLINDER

High Security ISEO R90 Factory Monoprofile. Up to 3 mechanical recordings. Usage detected by electronics. KA on the same installation.

EXTERNAL EMERGENCY POWER SUPPLY

For installations with no override cylinder. Connector under external cover plate. Standard 9V battery usage.

PRIVACY DEVICE

Internal ergonomic knob to activate privacy. Signal reset after each door opening.

Aries Smart 2.1 For custom handles, for panic devices

ELECTRONIC TRIM RFID/BLUETOOTH® SET FOR PANIC DEVICES

CODE CONFIGURATOR

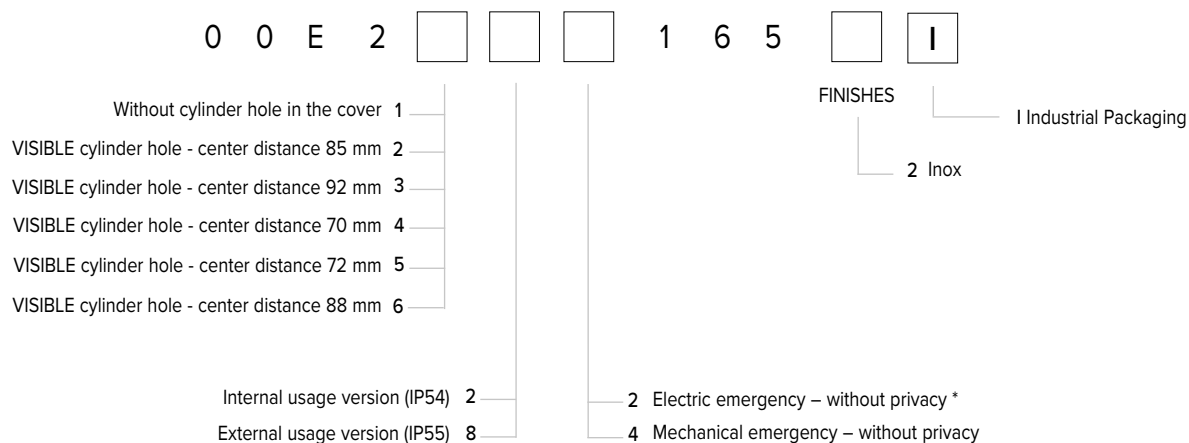
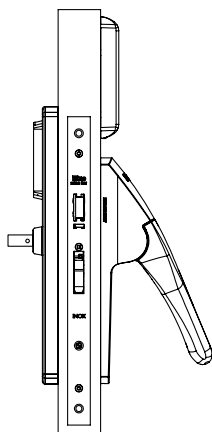

* ONLY compatible to configuration
 Without cylinder hole in the cover
 (code 1 in fifth position)

Product options

OVERRIDE CYLINDER HOLE EXTERNAL SIDE

To chose if a mechanical emergency cylinder is used. The mechanical cylinder is still accessible without cylinder hole, by turning the plate.

IP RATING

For internal (IP54) or external (IP55 with resistance to salty atmosphere) usage.

EMERGENCY OVERRIDE CYLINDER

High Security ISEO R90 Factory Monoprofile. Up to 3 mechanical recordings. Usage detected by electronics. KA on the same installation.

EXTERNAL EMERGENCY POWER SUPPLY

For installations with no override cylinder. Connector under external cover plate. Standard 9V battery usage.

Aries Smart 2.1 For DIN lock

ELECTRONIC TRIM RFID/BLUETOOTH® SET FOR DIN LOCK

CODE CONFIGURATOR

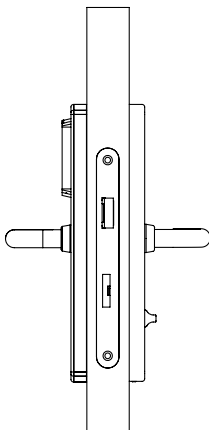

0 0 E 1 1 6 5

VISIBLE cylinder hole - center distance 72 mm 8
 Without cylinder hole in the cover B

FINISHES
 2 Inox

Internal usage version (IP54) 1
 External usage version (IP55) 7

- 1 Electric emergency – with privacy *
- 2 Electric emergency – without privacy *
- 3 Mechanical emergency – with privacy
- 4 Mechanical emergency – without privacy

* ONLY compatible to configuration
 Without cylinder hole in the cover
 (code B in fifth position)

Product options

OVERRIDE CYLINDER HOLE EXTERNAL SIDE

IP RATING

EMERGENCY OVERRIDE CYLINDER

EXTERNAL EMERGENCY POWER SUPPLY

PRIVACY DEVICE

To chose if a mechanical emergency cylinder is used. The mechanical cylinder is still accessible without cylinder hole, by turning the plate.

For internal (IP54) or external (IP55 with resistance to salty atmosphere) usage.

High Security ISEO R90 Factory Monoprofile. Up to 3 mechanical recodings. Usage detected by electronics. KA on the same installation.

For installations with no override cylinder. Connector under external cover plate. Standard 9V battery usage.

Internal ergonomic knob to activate privacy. Signal reset after each door opening.

Aries Smart 2.1 For fire locks

ELECTRONIC TRIM RFID/BLEETOOTH® SET FOR FIRE LOCKS

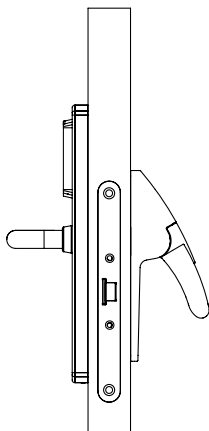

CODE CONFIGURATOR

0 0 E 1 9 0 1 6 5

Internal usage version (IP54) 2
 External usage version (IP55) 8

FINISHES
 2 Inox

Product options

IP RATING

For internal (IP54) or external (IP55 with resistance to salty atmosphere) usage.

Aries Smart 2.1 For Premi Apri Meroni locks

ELECTRONIC TRIM RFID/BLEETOOTH® SET FOR PREMI APRI MERONI LOCKS

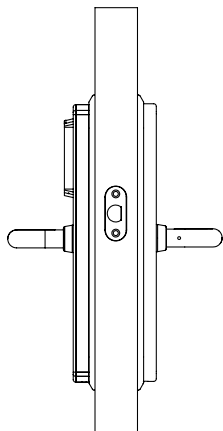

CODE CONFIGURATOR

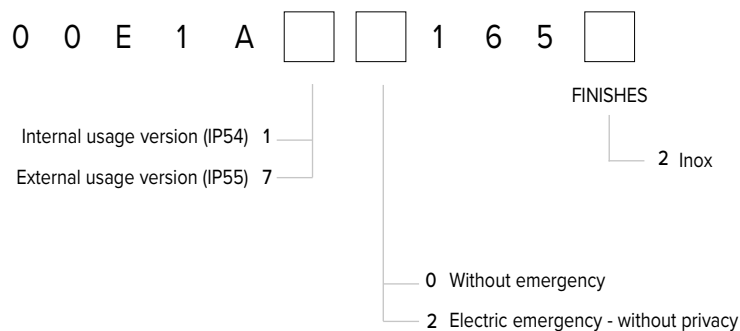

Product options

IP RATING	EMERGENCY OVERRIDE CYLINDER	EXTERNAL EMERGENCY POWER SUPPLY	PRIVACY DEVICE
For internal (IP54) or external (IP55 with resistance to salty atmosphere) usage.	High Security ISEO R90 Factory Monoprofile. Up to 3 mechanical recodings. Usage detected by electronics. KA on the same installation.	For installations with no override cylinder. Connector under external cover plate. Standard 9V battery usage.	Internal ergonomic knob to activate privacy. Signal reset after each door opening.

Libra X Smart Standard

MODULAR CYLINDER WITH EXTERNAL RFID/BLUETOOTH® ELECTRONIC KNOB (FREE ROTATION) AND INTERNAL MECHANICAL KNOB (STANDARD TYPE)

CODE CONFIGURATOR

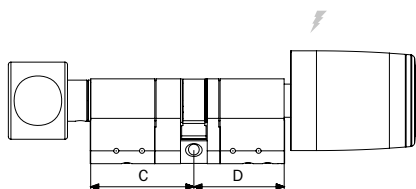

8	M	X	<input type="text"/>	8	<input type="text"/>	<input type="text"/>	<input type="text"/>	6	5	<input type="text"/>
					DIMENSION C	DIMENSION D	FINISHES			P PANIC function ***/**
			Heavy Duty 1		30**/**	30				
			Standard 2		35	35				
			Removable external knob (Heavy Duty) **/**		40	40				
					45	45				
					50	50				
					55	55				
					60	60				
					65	65				
					70	70				
					75	75				
								
								
					130	130		24		Inox - Matte White
								25		Inox - Matte Black

L max 260 mm

** not available Panic function version
 *** not compatible with version "external removable knob"
 **** L max 180 mm (L max per side 90 mm)

Product options

HEAVY DUTY LIBRA X KNOB

Version with drilling protection on the opening mechanism.

REMOVABLE EXTERNAL KNOB

Removable knob (Heavy Duty characteristics).

PANIC VERSION FOR PANIC LOCK

Freely rotating with cam returning in vertical position.

Libra X Smart Premium

MODULAR CYLINDER WITH EXTERNAL ELECTRONIC RFID/BLUETOOTH® KNOB (FREE ROTATION) AND INTERNAL MECHANICAL KNOB (PREMIUM TYPE)

CODE CONFIGURATOR

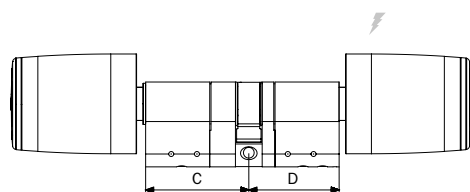

8 M X 0 6 5

	DIMENSION C	DIMENSION D	FINISHES
Heavy Duty 1	30**/***	30	P PANIC function ***/**** 24 Inox - Matte White 25 Inox - Matte Black
Standard 2	35	35	
Removable external knob (Heavy Duty) **/****	40	40	
	45	45	
	50	50	
	55	55	
	60	60	
	65	65	
	70	70	
	75	75	
	
	
	130	130	

L max 260 mm

** not available Panic function version
 *** not compatible with version "external removable knob"
 **** L max 180 mm (L max per side 90 mm)

Product options

HEAVY DUTY LIBRA X KNOB

Version with drilling protection on the opening mechanism.

REMOVABLE EXTERNAL KNOB

Removable knob (Heavy Duty characteristics).

PANIC VERSION FOR PANIC LOCK

Freely rotating with cam returning in vertical position.

Libra X Smart Half

MODULAR HALF KNOB CYLINDER
 WITH EXTERNAL ELECTRONIC RFID/BLUETOOTH®
 KNOB (FREE-ROTATING)

CODE CONFIGURATOR

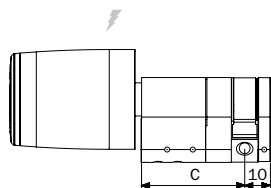

8 M X 0 1 0 6 5

	DIMENSION C	DIMENSION D	FINISHES
Heavy Duty 1	30 **		24 Inox - Matte White 25 Inox - Matte Black
Standard 2	35		
Removable external knob (Heavy Duty) ***	40		
	45		
	50		
	55		
	60		
	65		
	70		
	75		
	...		
	...		
	180		

L max 190 mm

** Libra monoprofile 30/10 removable reader is not modular. Length 35/10 and up is modular.
 *** L max 90/10

Product options

HEAVY DUTY LIBRA X KNOB

Version with drilling protection on the opening mechanism.

REMOVABLE EXTERNAL KNOB

Removable knob (Heavy Duty characteristics).

Libra X Smart Double

MODULAR CYLINDER WITH EXTERNAL ELECTRONIC
 RFID/BLUETOOTH® KNOB (FREE-ROTATING) AND
 INTERNAL ELECTRONIC KNOB (FREE-ROTATING)

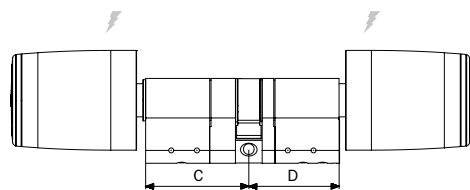

CODE CONFIGURATOR

8 M X E 6 5

	DIMENSION C	DIMENSION D	FINISHES
Heavy Duty 1		30	24 Inox - Matte White 25 Inox - Matte Black
Standard 2	35	35	
	40	40	
	45	45	
	50	50	
	55	55	
	60	60	
	65	65	
	70	70	
	75	75	
	
	
	90	90	

L max 180 mm

** C = side with removable electronic knob

Product options

HEAVY DUTY LIBRA X KNOB

Version with drilling protection on the
 opening mechanism.

Libra X Smart Removable reader and Extension plug 16 mm

MODULAR CYLINDER FOR ARMORED DOORS WITH EXTERNAL ELECTRONIC RFID/BLEETOOTH® KNOB (FREE ROTATION), COMPATIBLE WITH CYLINDERS ESCUTCHEON, EXTENSION PLUG AND PRE-ARRANGED FOR INTERNAL KNOB SHAFT D 8X16 MM

CODE CONFIGURATOR

8 M X 3 6

6 5

DIMENSION

C

DIMENSION

D

FINISHES

30

30

35

35

40

40

45

45

50

50

55

55

60

60

70

70

...

...

...

...

90

85

- 24 Inox - Matte White
- 25 Inox - Matte Black

L max 175 mm

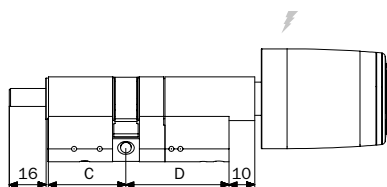

Product options

HEAVY DUTY
 LIBRA X KNOB

Version with drilling protection on the opening mechanism.

Libra X Smart Removable reader and Extension plug 75 mm

MODULAR CYLINDER FOR ARMORED DOORS WITH EXTERNAL ELECTRONIC RFID/BLUETOOTH® KNOB (FREE ROTATION), COMPATIBLE WITH CYLINDERS ESCUTCHEON, EXTENSION PLUG AND PRE-ARRANGED FOR INTERNAL KNOB SHAFT D 8X75 MM

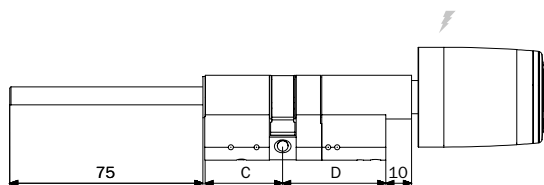

CODE CONFIGURATOR

8 M X 3 6 D 0 6 5

DIMENSION
C

DIMENSION
D

FINISHES

30

35

40

45

50

55

60

70

...

...

85

24 Inox - Matte White

25 Inox - Matte Black

L max 115 mm

Product options

HEAVY DUTY
 LIBRA X KNOB

Version with drilling protection on the opening mechanism.

Libra X Smart Dummy-knob

MODULAR CYLINDER FOR ARMORED DOORS WITH EXTERNAL ELECTRONIC RFID/BLUETOOTH® KNOB (FREE ROTATION) AND KNOB-DUMMY ON INTERNAL SIDE

CODE CONFIGURATOR

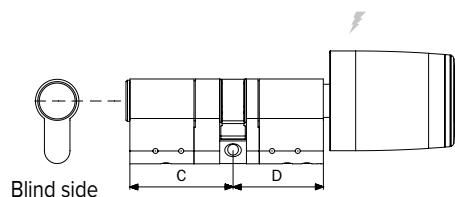

8 M X C 6 5

	DIMENSION C	DIMENSION D	FINISHES
Heavy Duty 1	30 ^{**} / ^{****}	30	P PANIC function ^{***} / ^{****} 24 Inox - Matte White 25 Inox - Matte Black
Standard 2	35	35	
Removable external knob (Heavy Duty) ^{**} / ^{****}	40	40	
	45	45	
	50	50	
	55	55	
	60	60	
	65	65	
	70	70	
	75	75	
	
	
	130	130	

L max 260 mm

^{**} not available Panic function version
^{***} not compatible with version "external removable knob"
^{****} L max 180 mm (L max per side 90 mm)

Product options

HEAVY DUTY LIBRA X KNOB

Version with drilling protection on the opening mechanism.

REMOVABLE EXTERNAL KNOB

Removable knob (Heavy Duty characteristics).

PANIC VERSION FOR PANIC LOCK

Freely rotating with cam returning in vertical position.

Libra X Smart Oval Australian

OVAL AUSTRALIAN ELECTRONIC CYLINDER
 WITH EXTERNAL RFID/BLUETOOTH® ELECTRONIC
 KNOB (FREE ROTATION)

CODE CONFIGURATOR

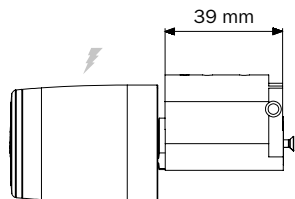

8 S X 9 0 0 6 5

Heavy Duty 1
 Standard 2

DIMENSION
 39

FINISHES

24 Inox - Matte White
 25 Inox - Matte Black

Product options

HEAVY DUTY
 LIBRA X KNOB

Version with drilling protection on the
 opening mechanism.

Libra X Smart Oval Scandinavian

OVAL SCANDINAVIAN ELECTRONIC CYLINDER
 WITH EXTERNAL ELECTRONIC RFID/BLEETOOTH®
 KNOB (FREE ROTATION)

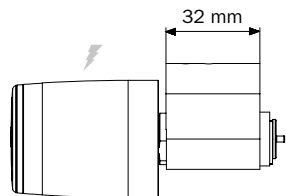

CODE CONFIGURATOR

8 S X 2 0 0 6 5

Heavy Duty 1
 Standard 2

DIMENSION
 32

FINISHES

24 Inox - Matte White
 25 Inox - Matte Black

Product options

HEAVY DUTY LIBRA X KNOB

Version with drilling protection on the opening mechanism.

Multiblindo Smart

MOTORIZED SELF-LOCKING MULTI-POINT LOCK,
 WITH A HIGH LEVEL OF SECURITY, SUITABLE FOR
 METAL FRAME DOORS MULTIPLE LOCKING POINTS,
 TO BE COMBINED WITH CONNECTION BOX

CODE CONFIGURATOR

7 A 3 E 2 5

FRONT SHAPE

BACKSET

D Right
S Left

U-shaped - stainless steel - 24x6x2300 mm 00
 Flat front- stainless steel - 24x3x2300 mm 10

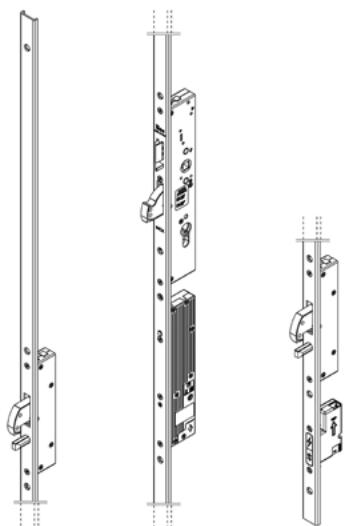

Product options

FRONT SHAPE

Flat front 24X3 mm stainless steel.
 U-shaped front 24X6 mm stainless steel.

BACKSET (mm)

Available in versions with
 35,40,45,50,55,60,65 mm backset











RIGHT/LEFT

Right and left version
 according to DIN 107.

Phased out products









The table shows the replacement codes for phased out products. If no replacement code is available, please consult the catalogue to assess the right product solution.

 Accessories for discontinued items

Code	Product model	Title	Description	Substitution code	Go to page
00E1xxx155x	Aries Smart 2.0	Standard	Electronic trim RFID/Bluetooth® Set standard	00E1xxx165x	→ 
00E1xxx155x	Aries Smart 2.0	For panic devices	Electronic trim RFID/Bluetooth® set for panic devices	00E1xxx165x	→ 
00E2xxx155xl	Aries Smart 2.0	For custom handles	Electronic trim RFID/Bluetooth® set for custom handles	00E2xxx165xl	→ 
00E2xxx155xl	Aries Smart 2.0	For custom handles for panic devices	For custom handles for panic devices electronic trim RFID/Bluetooth® set for panic devices	00E2xxx165xl	→ 
00E1xxx155x	Aries Smart 2.0	For DIN lock	Electronic trim RFID/Bluetooth® set for din lock	00E1xxx165x	→ 
00E19x0155x	Aries Smart 2.0	For fire locks	Electronic trim RFID/Bluetooth® set for fire locks	00E19x0165x	→ 
00E1Axx155x	Aries Smart 2.0	For Premi Apri Meroni locks	Electronic trim RFID/Bluetooth® set for premi apri meroni locks	00E1Axx165x	→ 
8MKx8xxxxxx65x	Libra LE60 Smart 2.1	Standard	Modular cylinder with external electronic knob (free rotation) and internal mechanical knob (standard type)	8MKx8xxxxxx65x	→ 
8MKx0xxxxxx65x	Libra LE60 Smart 2.1	Premium	Modular cylinder with external electronic knob (free rotation) and internal mechanical knob (premium type)	8MKx0xxxxxx65x	→ 
8MKx0xx10xx65x	Libra LE60 Smart 2.1	Half	Modular half knob cylinder with external electronic knob (free-rotating)	8MKx0xx10xx65x	→ 

Phased out products

 Accessories for discontinued items

Code	Product model	Title	Description	Substitution code	Go to page
8MKxExxxxx65	Libra LE60 Smart 2.1	Double	Modular cylinder with external electronic knob (free-rotating) and internal electronic knob (free-rotating)	8MKxExxxxx65	→ 
8MK36xxxxx65	Libra LE60 Smart 2.1	Removable reader and Extension plug 16 mm	Modular cylinder for armored doors with external electronic knob (free rotation), compatible with cylinders escutcheon, extension plug and pre-arranged for internal knob shaft D 8x16 mm	8MK36xxxxx65	→ 
8MK36D0xxxx65	Libra LE60 Smart 2.1	Removable reader and Extension plug 75 mm	Modular cylinder for armored doors with external electronic knob (free rotation), compatible with cylinders escutcheon, extension plug and pre-arranged for internal knob shaft D 8x75 mm	8MK36D0xxxx65	→ 
8MKxCxxxx65x	Libra LE60 Smart 2.1	Dummy-knob	Modular cylinder for armored doors with external electronic knob (free rotation) and knob-dummy on internal side	8MKxCxxxx65x	→ 
8SKx90039xx65	Libra LE60 Smart 2.1	Oval Australian	Oval Australian electronic cylinder with external electronic knob (free rotation)	8SKx90039xx65	→ 
8SKx20032xx65	Libra LE60 Smart 2.1	Oval Scandinavian	Oval Scandinavian electronic cylinder with external electronic knob (free rotation)	8SKx20032xx65	→ 
5E1320156	Stylos Smart 2.0	Credential reader with led	Credential reader with led	5E152315	→ 
5E1320456	Stylos Smart 2.0	Credential reader with display and numeric keypad	Credential reader with display and numeric keypad	5E152325	→ 
5E1322106	Stylos Smart 2.0	All-weather credential reader module	All-weather credential reader module	-	-
5E0555010	Stylos Smart 2.0	Control unit for all-weather module	Control unit for all-weather module	-	-

Accessories for discontinued items

Accessories

BATTERY

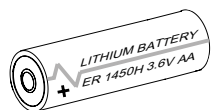

BATTERY FOR POWER SUPPLY (Compatible only with Aries 2.0)
 Lithium battery.Size AA, 3.6V DC.
 Size AA, 3,6Vcc.

10 58200000E0360

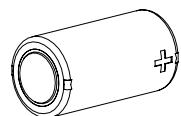

BATTERY (Compatible only with Libra LE60 2.0)
 FDK CR17335EF lithium battery 3V 1400 mAh.
 Size AA, 3,6Vcc.

1 0033960



ISEO[®]
ULTIMATE ACCESS TECHNOLOGIES

ISEO Serrature S.p.A.
Via San Girolamo, 13
25055 Pisogne BS, Italy
Tel. +39 0364 8821
Fax +39 0364 882263
iseo@iseo.com

iseo.com